

Energy Analysis of an Air Heat Pump for Hot Water

Mariusz Szreder

Warsaw University of Technology, Faculty of Civil Engineering, Mechanics and Petrochemistry
Department of Mechanical Systems Engineering and Automation
Al. Jachowicza 2/4, 09-402 Płock, e-mail: szreder@pw.plock.pl

Received January 20.2016; accepted January 26.2016

Summary. The paper presents selected issues relating to the energy analysis of the air heat pump for hot water. Experimental studies on a test stand made it possible to verify the operational parameters of the heat pump under actual conditions of use.

The study shows that heating the water in the storage tank with the capacity of 130 dm³ from 25°C to 40°C took approximately 60 minutes and the water heating for another 5°C took 30 minutes longer. The heat pump process in the field of higher water temperature in the tank is less effective, thus heating the water in the tank above 50°C is less favorable economically.

Key words: air heat pump, condenser, rotary compressor, storage tank, coefficient of performance COP.

INTRODUCTION

The heat pump has become, in the recent years, a relatively popular solution for heating the hot water. This is mainly due to the low purchase price and simplicity of installation of the system. Its advantage, compared to solar systems, is the lower price of the investment and the production of hot water almost throughout the year [4, 9, 11].

The heat pump heats the hot water using the heat energy from the air ventilation of the building. It fully covers the total demand of a detached house for hot water [1, 10, 13]. Thanks to the heat pump we can simultaneously achieve two energy effects: we can heat hot water and at the same time cool the interior of the building in the summer.

Except for a small additional investment cost associated with the purchase of ventilation elements, this function does not increase the current operating costs, because chilled “used” air removed from the heat pump is used.

We should not treat this type of cooling as the main type in a building. It is only an additional and active function, when the heat pump is in the heating water mode. It can be assumed that during the day under standard conditions, the heat pump will work no more than 5 ÷ 6 hours and at

this time, the room will be able to be additionally cooled [4, 12, 17, 18].

The room, where the appliance is installed, should be warm (for example, a boiler room or basement). However, it is best suited in areas where other devices emitting heat are located: laundry or drying room. In these areas, the pump will cool and dry air. It is surely advantage of heat pumps for hot water. It turns out that the hot water is heated economically, and rooms are dry and free from moisture, mildew and odors.

The heat pump water can be installed in rooms with a capacity of more than 80 m³ or in smaller ones providing proper ventilation for fresh air supply in the amount required by the heat pump (depending on the type and power of the heat pump from 250 to 500 m³/h) [5, 7]. The heat pumps in combination with the ventilation ducts can decide the conditions of the heat pump, depending on the season. In winter, the air is taken from the room interior and removed to the outside. In summer, warm air is drawn from the outside and injected into the room for its periodic cooling.

On the market we can find different technical solutions designed exclusively for heating domestic water, those which contain integral water tank and those which are designed to work with the existing heating system in the building (Fig. 1). The modular variant of heat pump (without tank) allows an easy installation of the heat pump in the boiler room, where, for example, solid fuel boiler and water tank, which needs to be replaced with a new one, are located [2, 12].

Heat pump ventilator draws warm air from the room and forces it through the evaporator, where the air is cooled by approx. 5 ÷ 7° C, and then it is removed outside the building or in the same room [6, 8, 14]. Thanks to a slight cooling of the air, the heat pump collects a large amount of heat, which is used to heat the water in the tank. In summer, the warm air is drawn from the outside and slightly chilled air on the evaporator can be directed into the interior of the building.

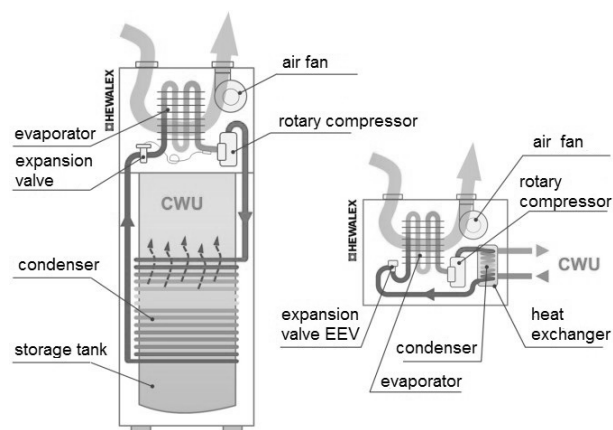

Fig. 1. Diagram of the functional air heat pump for hot water

The heat pump works efficiently as a separate or complementary system of hot water in a residential building.

The hot water pumps are most commonly equipped with storage tanks of 250 ÷ 300 dm³ capacity. The heat pump consumes an average of 3.5 kWh of electric energy to heat water in the storage tank from 15°C to 50°C, thus one-time cost of heating the water is approx. 2 PLN [2, 9, 17].

Water heat pumps can replace solar panels. However, you should be aware of both their advantages and limitations. Despite the high work efficiency, the lowest operating costs are involved in the solar system, which is also a less complex device with proven reliability and durability. The heat pumps are also covered by shorter warranty periods which, depending on the manufacturer, are from 2 to 5 years (a validity period for a solar panel is usually 10 years).

TEST STAND

The use of a heat pump with integrated hot water tank to build the test stand would practically limit the ability to conduct research only on the air heat pump for Domestic Hot Water needs. In order to eliminate the limitations resulting from the construction of the condenser, Hewalex air heat pump offered in a version with an external hot water tank was used to the proposed test stand. This solution enables the use of storage tanks of different capacities of water to tests, but above all thanks to a separate case of condenser of heat pump it is possible to use the components of this pump station for the expansion of station of central heating [13, 14, 16]. Fig. 2 presents a classic scheme of heat pump case with the capacity of 2.5 kW.

One characteristic aspect for this heat pump is the connection of the upper source to the circulation in the storage tank and not to the built-in coil. In the proposed test stand two tanks with the capacity of 130 dm³ were used. This solution will enable to test the heat pump with a variable thermal load of the upper heat source.

The planned test stand is equipped with the EKONTROL system offered by Hewalex as additional equipment. The controller device connects via modem EKO-LAN to the

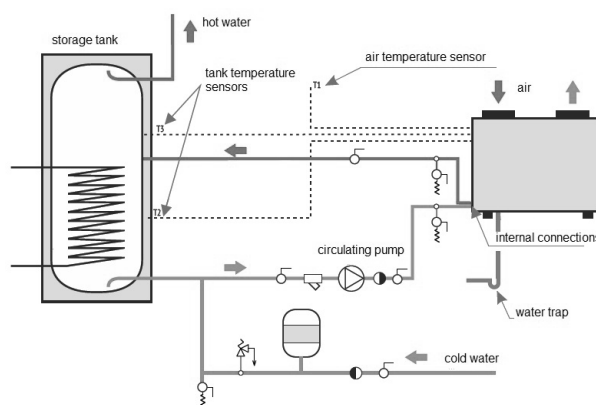

Fig. 2. Scheme of the heat pump installation in the domestic hot water circuit system

Internet and transmits data to the EKONTROL system. The combination also works in the opposite direction – users can connect to the controller via EKONTROL system from any device that has Internet access.

The test stand was equipped with an additional measuring module to study the COP (coefficient of performance) with access to the database on ekontrol.pl website. After logging on the portal you can read the current values of recorded temperatures of the heat pump components (Fig. 3).

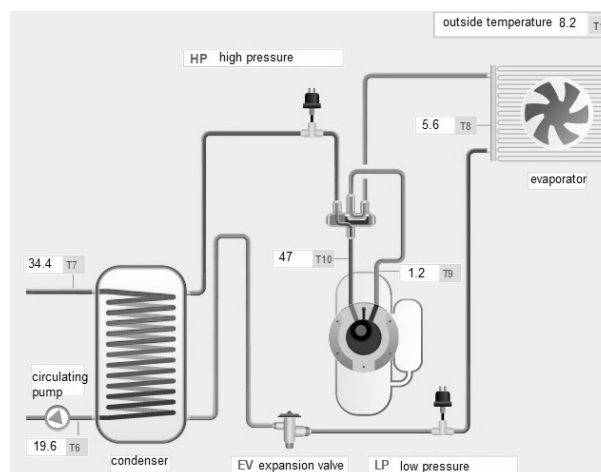

Fig. 3. Diagram of measurement path of components of the air heat pump with the capacity of 2.5 kW

The expansion of the measurement and control system with the module G922-COP also enables measurement of the flow of water and electricity consumption by the compressor. As a result, it is possible to determine the instantaneous values of the COP coefficient (Fig. 4).

Figure 5 shows the characteristics of the heat pump as contained in the catalog.

The presented characteristics show that an effective use of the pump is possible provided that the pump is connected to the ventilation ducts. Then, during the summer season air is drawn from the outside and, additionally, the function of cooling the room is used. In the winter time, ventilation air is taken and the cooled air must be removed outside the building.

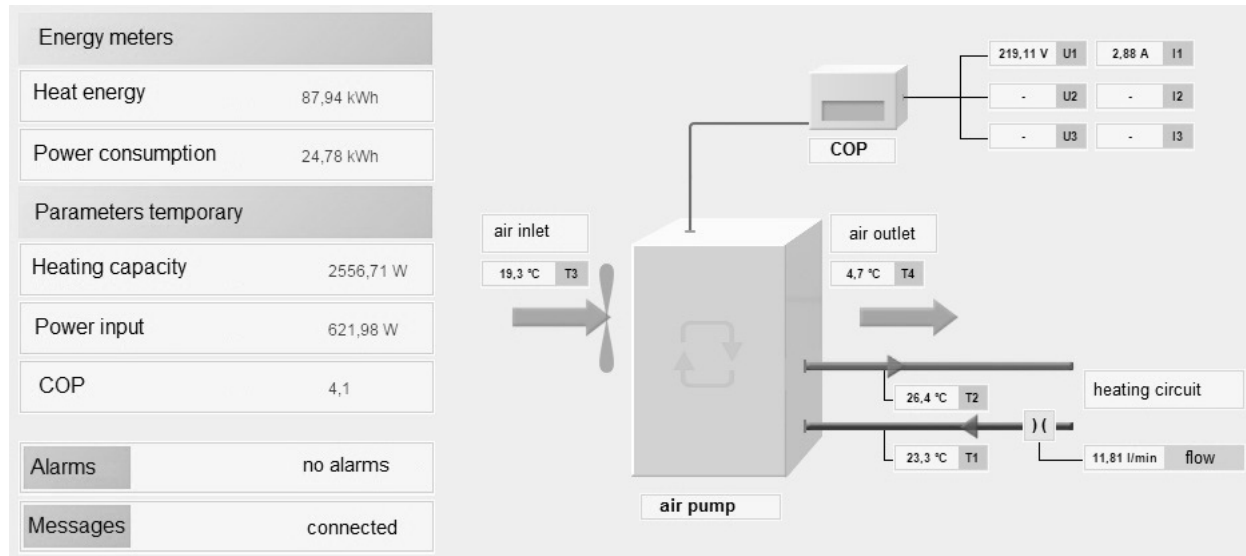

Fig. 4. The read panel of the measured parameters of module G922-COP

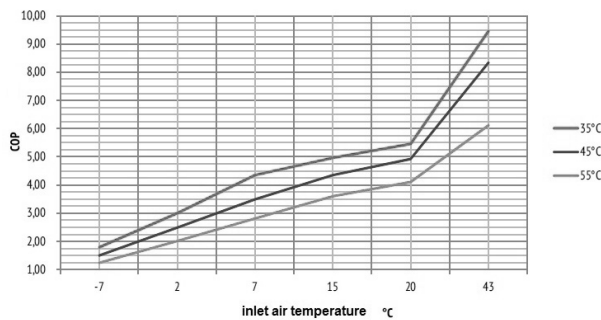

Fig. 5. The COP of air heat pump with a capacity of 2.5 kW

RESULTS OF RESEARCH

Preliminary tests of the heat pump were carried out during the assembly works of test stand. Running water from the water supply was connected to the upper heat source. It was necessary to suppress the flow of water to the level of 1.5 dm³/min with the rated power of the heat pump of 2.5 kW and cold water supply (14°C), so the heat pump works at an acceptable temperature range. The study used the ventilation air of laboratory room and outdoor air.

At the beginning of the study, the ventilation air in the laboratory room was used. The measurement data, shown in Fig. 6, show that in the case of ventilation air use the temperature of evaporation of refrigerant was maintained at 8°C, and the temperature of the outlet water from the upper source was 36°C. When changing the ventilation ducts to supply, outside air has put pressure on the lowering of the temperature of evaporation of the refrigerant, which caused a decrease of the coefficient of performance (COP) value.

Fig. 7 shows the recorded temperature changes in the module G922-COP for the case of the use of air ventilation and heating circuit connected to the water tank. It was necessary to shift the circulation pump in the heating circuit on the first gear at the water temperature in the tank of 23°C so that the compressor could operate within the recommended temperature range [3, 15].

The increase in water temperature in the tank gradually forced the increase in water temperature in the heating circuit, thus there was also the increase in the condensing temperature. As the temperature in the heating circuit increases, energy demand for heating gradually decreases, which was reflected by the increase in temperature of the air at the outlet of evaporator.

Fig. 8 presents the data recorded in the module G922-COP for the case of switching the ground source with power ventilation air to outside air supply. In the case of ventilation air supply, condensing temperature of refrigerant remained at 4.6°C, and after switching on the outside air supply the temperature of evaporation slightly decreased to 4°C, which did not cause significant changes in the thermodynamic equilibrium of the heat pump.

The results of the initially carried out measurements show that the air heat pump obtained the highest COP = 3.9 in the first phase of heating the water in the tank (Fig. 9). The current used by the compressor was below 3 A, and the demand for electric power was 600 W. In the final phase of heating, the heat pump efficiency fell to the value of COP = 2.9, and the demand for electric power increased to 950 W.

CONCLUSIONS

During the laboratory research, measurement data were stored in the database system of EKONTROL. The study shows that heating the water in the storage tank with the capacity of 130 dm³ from 25°C to 40°C took approximately 60 minutes and the water heating by another 5°C took 30 minutes longer. Operation of the heat pump in the field of higher water temperature in the tank is less effective, thus heating the water in the tank above 50°C is economically less favorable.

In the system of controlling the heat pump, the “compressor lock” is automatically activated if the supply air temperature heat source falls below 0°C, due to the low value

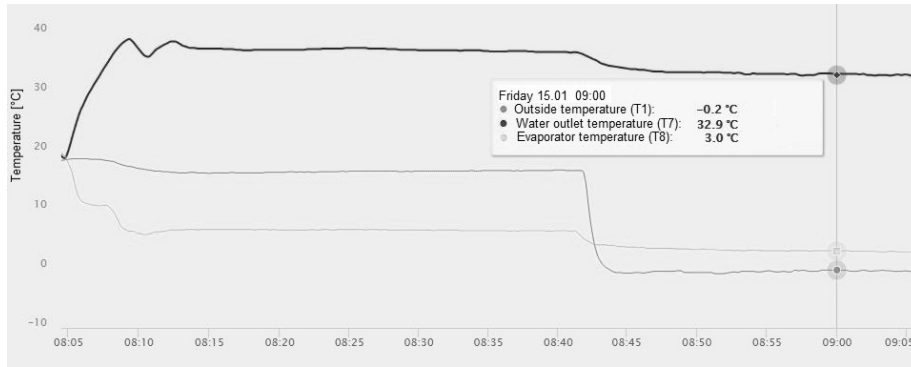

Fig. 6. Chart of temperatures in the heat pump for heating circuit connected to the water supply network.

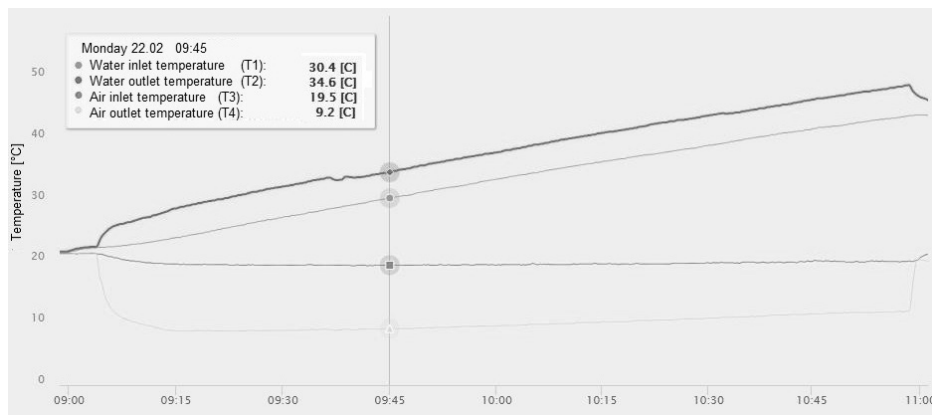

Fig. 7. Chart of temperature changes in the module G922-COP for heating circuit connected to the water tank.

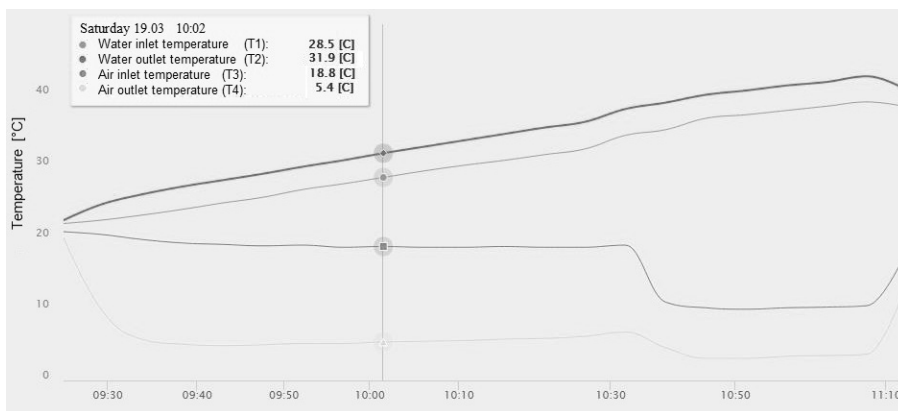

Fig. 8. Chart of temperature changes in the module G922-COP for the case of switching on the outside air supply

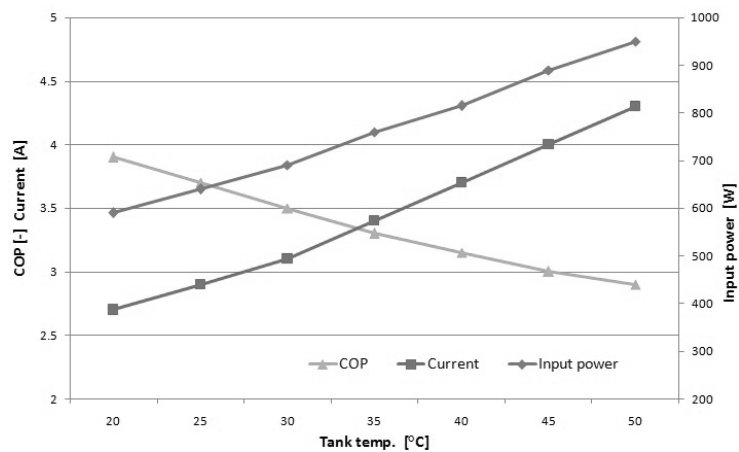

Fig. 9. List of registered current value, electrical power consumption and COP for the case of air ventilation

of the COP. This means that for low temperature, operation of the pump with the use of outdoor air is not economical. Operation of the pump during the winter season is possible with the use of ventilation air, but with an outlet of cooled air outside the building [15, 18].

During the heating cycle, water in the storage tank decreases the efficiency of the heat pump from COP = 3.9 in the initial phase of heating to the value of COP = 2.9 for the temperature of water in the tank at 50°C.

REFERENCES

1. **Horyński M. 2010:** Reasonable energy management in an intelligent building. TEKA Commission of Motorization and Energetics in Agricultures, vol. 10C, 87-94.
2. **Kaluźny R. 2015:** Dlaczego warto stosować powietrzne pompy ciepła. InstalReporter nr 8, 9-12.
3. **Kapuściński J., Rodzoch A. 2010:** Geotermia niskotemperaturowa w Polsce i na świecie – stan aktualny i perspektywy rozwoju. Wyd. Borgis, Warszawa.
4. **Karczmarczyk A. 2015:** Nowa generacja pomp ciepła do CWU. InstalReporter nr 2, 10-12.
5. **Knaga J. 2007:** Changeability of heat output of heat pump with scroll type compressor. TEKA Commission of Motorization and Energetics in Agricultures, vol. 7A, 41-45.
6. **Kurpaska, S., Latała, H. 2012:** Energy efficiency of ground heat exchangers co-operating with compressor heat pump. TEKA, Commission of Motorization and Energetics in Agricultures, vol. 12 No. 2, 151-156.
7. **Kurpaska, S., Latała, H. 2013:** Wytyczne konstrukcyjne dla systemu wykorzystującego pompę ciepła na potrzeby ogrzewania obiektu ogrodniczego. Inżynieria-Rolnicza, Z. 3, T. 1, 169-178.
8. **Miara M. 2011:** Sprawność pomp ciepła w realnych warunkach użytkowania. InstalReporter nr 2, 12-16.
9. **Piwowarczyk Sz. 2014:** Pompy ciepła powietrze/woda dla CWU. InstalReporter nr 9, 40-46.
10. **Rubik M. 2006:** Pompy ciepła – poradnik. Wyd. Ośr. Informacji „Technika Instalacyjna w budownictwie”, Warszawa.
11. **Smuczyńska M. 2012:** Rynek pomp ciepła w Polsce. Magazyn instalatora nr 11, 31-33.
12. **Szreder M. 2013:** Investigations into the influence of functional parameters of a heat pump on its thermal efficiency. TEKA Commission of Motorization and Energetics in Agricultures, vol. 13, nr 1, 191-196.
13. **Szreder M. 2013:** Dobór podzespołów gruntowej pompy ciepła. MOTROL Motoryzacja i Energetyka Rolnictwa, vol. 15, nr 1, 149-152.
14. **Szreder M. 2014:** A Study of a Heat Pump Ground Collector. TEKA Commission of Motorization and Energetics in Agricultures, vol. 14, nr 3, 121-128.
15. **Szreder M. 2014:** A field study of the performance of a heat pump installed in a low energy house. Applied Thermal Engineering, vol. 71, nr 1, 596-606.
16. **Szreder M. 2015:** Badania porównawcze zaworów rozprężnych w pompie ciepła. MOTROL Motoryzacja i Energetyka Rolnictwa, vol. 17, nr 1, 127-132.
17. **TPC 2015:** Strona internetowa firmy Technologie Pomp Ciepła Sp. z o.o.: www.technologiepc.pl.
18. **Viessmann 2015:** Efektywna technika grzewcza dla nowego budownictwa. Strona internetowa firmy Viessmann: <http://www.viessmann.pl>.

ANALIZA ENERGETYCZNA POWIETRZNEJ POMPY CIEPŁA DLA CWU

Streszczenie. W pracy zostały zaprezentowane wybrane zagadnienia dotyczące analizy energetycznej powietrznej pompy ciepła dla CWU. Przeprowadzone badania eksperymentalne na stanowisku badawczym umożliwiły weryfikację parametrów eksploatacyjnych pompy ciepła w rzeczywistych warunkach użytkowania.

Z przeprowadzonych badań wynika, że podgrzanie wody w zasobniku o pojemności 130 dm³ od temperatury 25°C do 40°C trwało średnio 60 minut, natomiast podgrzanie wody o kolejne 5°C zajmowało już 30 minut. Praca pompy ciepła w zakresie wyższej temperatury wody w zasobniku jest mniej efektywna, przez co podgrzewanie wody w zasobniku powyżej 50°C jest mniej korzystne ekonomicznie.

Słowa kluczowe: powietrzna pompa ciepła, skraplacz, sprężarka rotacyjna, zasobnik, współczynnik efektywności energetycznej COP.