





UNRAVELLING THE TANGLE OF THE AZECID LAND SNAILS: A SURVEY ON THE SUPRASPECIFIC SYSTEMATICS BASED ON COMPARATIVE MORPHOLOGY AND MOLECULAR PHYLOGENY (GASTROPODA: EUPULMONATA: ORTHURETHRA)

GIUSEPPE MANGANELLI^{1*}, DEBORA BARBATO¹, JOANNA R. PIEŃKOWSKA², ANDREA BENOCCI³,
ANDRZEJ LESICKI², FOLCO GIUSTI¹

¹Dipartimento di Scienze Fisiche, della Terra e dell'Ambiente, Università di Siena, Via Mattioli 4, 53100 Siena, Italy (e-mails: manganelli@unisi.it; debora.barbato87@gmail.com; fg@urfz.org);
GM  <https://orcid.org/0000-0002-8453-280X>, DB  <https://orcid.org/0000-0003-1105-1711>,
FG  <https://orcid.org/0000-0001-8722-4653>

²Department of Cell Biology, Institute of Experimental Biology, Faculty of Biology, Adam Mickiewicz University in Poznań, Uniwersytetu Poznańskiego 6, 61-614 Poznań, Poland
(e-mails: pienkowj@amu.edu.pl; alesicki@amu.edu.pl); JRP  <https://orcid.org/0000-0003-0372-121X>,
AL  <https://orcid.org/0000-0002-1924-1934>

³Museo di Storia Naturale dell'Accademia dei Fisiocritici, Piazzetta S. Gigli 2, 53100 Siena, Italy
(e-mail: andrea.benocci.76@gmail.com);  <https://orcid.org/0000-0003-3145-215X>

*corresponding author

ABSTRACT: A selection of 17 azecid species, including *Azeca goodalli*, *Gomeziella girottii*, *Hypnocardia micaelae*, four species of *Cryptazeca* and ten species currently assigned to *Hypnophila*, chosen among those best known, were investigated to elucidate their relationships based on morphological and molecular evidence. Thirty one characters, only 15 of which were parsimony informative, were scored from morphology. Parsimony analysis was performed with PAUP* 4.0 using *Cochlicopa lubrica* as outgroup. Sequences of COI and ITS2 deposited in GenBank were re-examined using *Cochlicopa lubrica* as outgroup. Phylogeny based on the morphological characters suggested that *Hypnophila* as formerly conceived was a polyphyletic taxon with four different lineages: *Gomeziella girottii* (1); *Hypnophila boissii* (2); the Dalmatian *Hypnophila* species except *H. zirjensis* (3); the western Mediterranean species plus *H. zirjensis* (4). Unfortunately molecular studies did not include *Gomeziella girottii* and species of Dalmatian *Hypnophila* and this biases full comparison between the two data sets. Moreover our re-analysis of the previous molecular data produced a slightly different phylogenetic hypothesis compared to the original one. Indeed, the only ML tree of COI sequences confirmed with weak bootstrap supported the phylogenetic hypothesis that *Hypnocardia micaelae* was the sister group to all the other azecids. On the contrary, the ML trees of ITS2 and of concatenated COI+ITS2 sequences found that *Azeca goodalli* was the sister group to all the other azecids, *Cryptazeca* was paraphyletic and *Hypnocardia micaelae* was the sister group of *Cryptazeca monodonta*. Comparing the results of the two data sets, it emerged that phylogenetic analysis based on morphological characters had good resolution but very low statistical support and that the position of *Hypnophila boissii* was the most variable. In morphological phylogeny this species had unresolved relationships with *Gomeziella girottii* and a clade including *Azeca goodalli* and all other species currently assigned to *Hypnophila*, whereas in the molecular phylogeny it was nested in the western *Hypnophila*. The latter result is followed here assigning the species now included in *Hypnophila* to two distinct genera: *Gomphroa* comprising the western species plus *Hypnophila zirjensis*; *Hypnophila* including the Dalmatian species except *Hypnophila zirjensis*.

KEY WORDS: Azecidae, morphological and molecular phylogeny, systematics, description of taxa



INTRODUCTION

Azecids are a group of small orthurethran land snails inhabiting the litter and topsoil of arid to humid open to forest environments. They occur in the western Palaearctic from the British Isles southward to the Iberian Peninsula and eastward to the western sector of the Balkan Peninsula in Europe and from Morocco to Algeria in North Africa (HOLYOAK & HOLYOAK 2012, WELTER-SCHULTES 2012, ŠTAMOL et al. 2018).

The systematic history of this group of land snails is intricate, due to the fact that they have been regarded as belonging to the orthurethran cochlicopids or to the sigmurethran ferussaciids. A family-group taxon for this group (“Azecinae”) was first introduced by WATSON (1920) as a subfamily of the Pupillidae to separate *Azeca* Fleming, 1828 from the usually considered closely allied *Cochlicopa* Férussac, 1821. Subsequently this family-group taxon was disregarded as a junior synonym of the Cochlicopidae (for the last examples see SCHILEYKO 1998a, BARKER 1999), only to be resurrected recently as a distinct family in the Cochlicopoidea (BANK et al. 2001, FALKNER et al. 2002) or as a distinct subfamily in the Cochlicopidae (BOUCHET & ROCROI 2005). MADEIRA et al. (2010) definitively demonstrated that the azecids were distinct from the cochlicopids and the ferussaciids: the azecids and all the other orthurethran groups examined belonged to the non-achatinoide clade, whereas the ferussaciids belonged to the sigmurethran achatinoide clade; within the orthurethrans, the azecids had unresolved relationships with the chondrinids and a large assemblage including all the other orthurethrans so far examined. After that the azecids were accepted as a distinct family within the orthurethran

pulmonates (e.g. HOLYOAK & HOLYOAK 2012, BANK & NEUBERT 2017, BOUCHET et al. 2017, CIANFANELLI et al. 2018a, b, ŠTAMOL et al. 2018).

According to BANK et al. (2001) and FALKNER et al. (2002), the azecids have only two genera, *Azeca* and *Hypnophila* Bourguignat, 1858. A third genus, *Gomphroa* Westerlund, 1902, is only recognised by SCHILEYKO (1998a). A fourth genus, *Cryptazeca* Folin et Bérillon, 1877(a), initially assigned to the sigmurethran ferussaciids, was recently allocated to the azecids on the basis of morphological (orthurethrous kidney) and molecular evidence (GÓMEZ & ANGULO 1987, MADEIRA et al. 2010). A fifth genus, *Gomeziella* Cianfanelli, Bodon, Giusti et Manganelli, 2018(a), was established for *Hypnophila girottii* Esu, 1978, a species first described from the Plio-Pleistocene of Sardinia (western Mediterranean) and then discovered alive (MANGANELLI et al. 1995, CIANFANELLI et al. 2018a). Finally a sixth genus, *Hypnocarnica* Cianfanelli et Bodon in Cianfanelli et al., 2018 was introduced for a new species (*Hypnocarnica micaelae* Cianfanelli et Bodon in Cianfanelli et al., 2018) from the Carnic Prealps, Italy (CIANFANELLI et al. 2018b).

Here we re-examine supraspecific level relationships of the azecids. We conducted a phylogenetic study on the basis of morphological characters, considering a selection of the best known species, including the type species of all the genus-group taxa of the family. Then we compared the results with those of two molecular phylogenies, one from CIANFANELLI et al. (2018b) and one based on a re-examination of the data of CIANFANELLI et al. (2018b). Finally we made a concise survey of all the azecid genera, preceded by re-description of the family.

MATERIAL AND METHODS

TAXONOMIC SAMPLE

Our analysis considered a selection of azecid species including *Azeca goodalli* (Férussac, 1821), *Gomeziella girottii*, *Hypnocarnica micaelae*, four species of *Cryptazeca* and ten species currently assigned to *Hypnophila* chosen among those best known.

OUTGROUP

Azecids have unresolved relationships with the chondrinids and a large assemblage including all the other orthurethran genera so far examined (MADEIRA et al. 2010). Under such uncertainty, we used *Cochlicopa lubrica* (Müller, 1774) (Figs 1–5), traditionally regarded as allied with the azecids, as outgroup.

MORPHOLOGICAL STUDY

For each species considered, detailed anatomical re-examination was performed on the available material. The bodies were isolated from the shells and dissected under the light microscope (Wild M5A) using very fine pointed watchmaker’s tweezers. Anatomical details were drawn using a Wild camera lucida.

When possible the material examined is listed as follows: locality, municipality and province names in parenthesis, UTM reference, collector(s), date, number of specimens and collection in which material is kept in parenthesis. Key to acronyms used in material examined: AMC – A. Margelli collection (Pisa, Italy); CGAH – D. T. Holyoak & G. A. Holyoak collection (Cabeçudo, Portugal); CNHM – Croatian



Figs 1–3. Shells of *Cochlicopa lubrica* (Müller, 1774): 1–2 – specimens from Mindelsee (09°02'E, 47°45'N) (district of Konstanz, Baden-Württemberg), G. ARMBRUSTER leg. 10.1992 (FGC 6439); 3 – a specimen from Mindelsee (09°01'E, 47°45'N) (district of Konstanz, Baden-Württemberg), G. ARMBRUSTER leg. 10.1992 (FGC 6440). Scale bar 2 mm

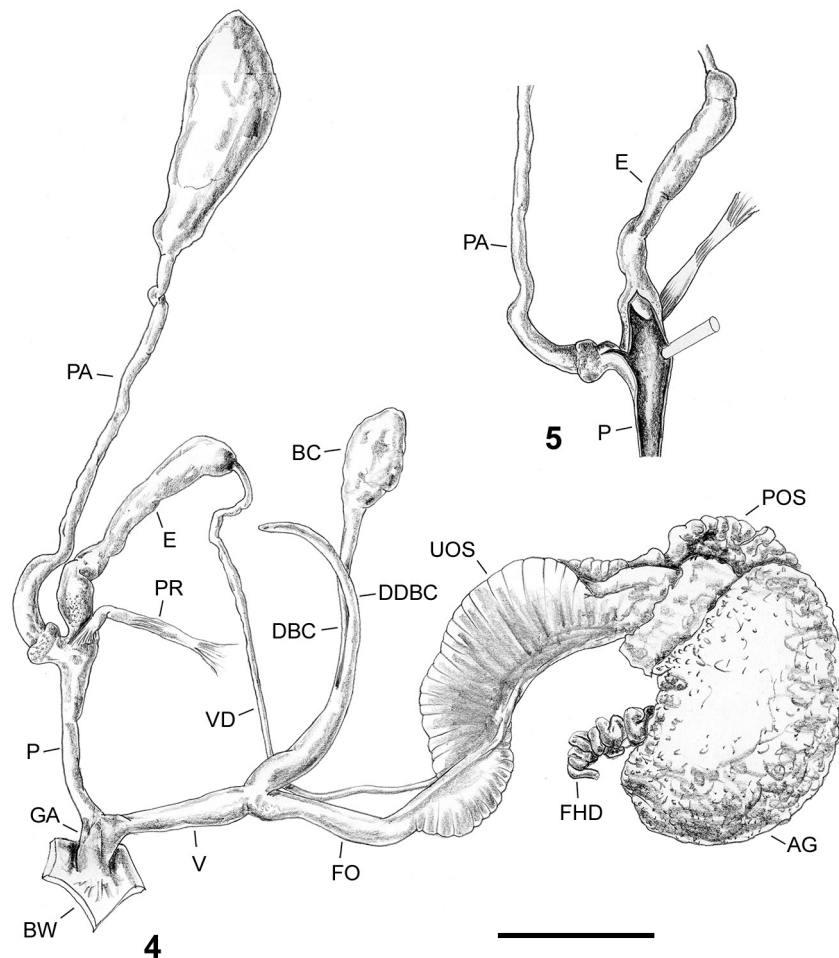

Figs 4–5. Genitalia of *Cochlicopa lubrica* (Müller, 1774): 4 – general view (gonad excluded); 5 – detail and internal structure of penial complex; a specimen from Tarvisio (province of Udine, Italy), F. GIUSTI leg. 4.9.1973. Scale bar 1 mm



Natural History Museum (Zagreb, Croatia); FGC – F. Giusti collection (Dipartimento di Scienze Fisiche, della Terra e dell’Ambiente, Università di Siena, Italy); MBC – M. Bodon collection (Genoa, Italy); MZB – Museu de Ciències Naturals (Barcelona, Spain); MZUF – Museo di Storia Naturale dell’Università di Firenze, Sezione Zoologica de “La Specola” (Florence, Italy); SCC – S. Cianfanelli collection (Florence, Italy).

Key to acronyms used in figures: AG – albumen gland; BC – bursa copulatrix; BW – body wall; DBC – duct of bursa copulatrix; DDBC – diverticulum of duct of bursa copulatrix; E – epiphallus; FHD – first hermaphrodite duct; FO – free oviduct; GA – genital atrium; P – penis; PA – penial appendix; PD – penial diverticulum; POS – prostatic portion of ovispermiduct; PR – penial retractor muscle; PS – penial sheath; UOS – uterine portion of ovispermiduct; V – vagina; VD – vas deferens; VM – vaginal muff. Other abbreviations in the text: D – shell maximum diameter; H – shell height; C, L, ML, M – radular teeth: central, lateral, latero-marginal and marginal, respectively.

In the shell description, apertural elements are defined: plicae or lamellae if they consist of elongated spiral structures situated in the palatum or parietum and columella respectively, teeth or denticles otherwise; the transversely elongated structure in the outermost parietum of many azecid species is named “angular tubercle” in line with SCHILEYKO (1998a).

In the anatomical description the use of directional (proximal and distal; basal and apical) and descriptive terms (short vs. long, slender vs. wide, etc.) was applied as follows. In the case of the ducts of the main axis of the genitalia (e.g. free oviduct, vagina, vas deferens, penis, etc.), proximal, basal or initial denotes the part which is closer to the gonad and distal, apical, final or terminal the part which is closer to the gonopore. In the case of the blind structures radiating from the main axis of the genitalia (bursa copulatrix complex, penial/vaginal/atrial appendix, etc.), basal or initial denotes the part closer to, and apical, final or terminal, the part further from the main axis of the genitalia. The descriptive terms (e.g. short vs. long, slender vs. wide, etc.) refer to comparisons of the same tract of the genitalia in different taxa. Unfortunately, only extreme cases are easy to evaluate; intermediate cases are very difficult to evaluate objectively due to large variation between taxa. Application of these simple categories is straightforward. Apparently simple structures (penis or even bursa copulatrix, duct of bursa copulatrix, etc.) may be so varied in different taxa as to elude any attempt at objective comparison. Besides the variation between taxa, sometimes differences may be due to different sexual maturation of the reproductive organs, fixation, and in the case of drawings in the literature,

different fidelity of illustration. Only examination of a considerable number of specimens by the same researcher can provide real insights, but this was not possible due to unavailability of material.

CHARACTERS

Thirty one characters were scored during examination of 17 azecid species belonging to the in-group, plus *Cochlicopa lubrica* used as outgroup (Table 1). Eighteen characters were parsimony uninformative; only thirteen characters were parsimony informative.

PHYLOGENETIC ANALYSIS

Maximum parsimony analysis was performed with PAUP* 4.0b10 (SWOFFORD 1998) with the following options: heuristic search mode with 1,000 random stepwise addition sequence replicates; tree bisection-reconnection branch swapping (TBR); MulTrees option “on”, saving all minimum trees found during branch swapping. All characters were considered unordered.

Once the initial heuristic search was completed, all the equally most-parsimonious trees were used for successive weighting to reduce the effect of potentially homoplastic characters (FARRIS 1969, KORES et al. 2000). Characters were assigned new weights using the Rescaled Consistency Index (RC) and a base weight of 100. Heuristic search was then performed on the reweighted matrix using branch swapping on all trees obtained in the previous analysis. After each search the characters were reweighted on the basis of the new trees and this procedure was repeated until a constant length was obtained. Multiple parsimonious trees were then summarised using a strict consensus method. To evaluate clade support, nonparametric bootstrap resampling with full heuristic search was used (1,000 bootstrap replicates, 10 random addition sequence replicates per bootstrap replicate, TBR swapping, MulTrees option “on”).

MOLECULAR ANALYSIS

Mitochondrial COI (cytochrome c oxidase subunit I) and 16S (16S ribosomal DNA) as well as nuclear ITS2 (internal transcribed spacer 2 of ribosomal DNA) partial gene sequences were obtained from GenBank. They were as follows: COI – MF545160 (DEWAARD 2017) and MG209139-MG209152 (CIANFANELLI et al. 2018b); 16S – GU331954 (DINAPOLI et al. 2011) and MG209153-MG209164 (CIANFANELLI et al. 2018b); ITS2 – AY014019 (WADE et al. 2001), AY546470 (ARMBRUSTER et al. 2005), FJ791121-FJ791123 (MADEIRA et al. 2010), MG209165-MG209179 (CIANFANELLI et al. 2018b).



Table 1. Description of characters used for morphological phylogenetic analyses

No.	Characters		Remarks
	Name	States	
1.	shell shape	0 = elongate ovoid-fusiform (<i>Cochlicopa</i> and <i>Azeca</i> like) 1 = elongate ovoid-cylindrical (<i>Hypnophila</i> like) 2 = elongate cylindrical-fusiform (<i>Gomphroa</i> like) 3 = very elongate, cylindrical-conical or cylindrical-fusiform (<i>Gomeziella</i> like) 4 = very elongate, cylindrical-conical or cylindrical-fusiform (<i>Hypnocarnica</i> like)	It is very difficult to propose an objective coding of shell shape variation due to significant intraspecies variability.
2.	whorls and sutures	0 = whorls slightly round and sutures deep 1 = whorls almost flat and sutures shallow	State 0 is unique to <i>Cochlicopa lubrica</i> (Müller, 1774).
3.	angular tubercle	0 = absent 1 = present	A transversely elongate tubercle is present in the outermost parietum of <i>Azeca goodalli</i> (Férussac, 1821) and most <i>Hypnophila</i> species ("triangular tooth near the upper angle" according to PILSBRY 1908; "angular tubercle" according to SCHILEVKO 1998a). State 1 is unique to <i>A. goodalli</i> .
4.	supraparietal denticle/knob/tubercle	0 = absent 1 = present	State 1 is unique to <i>A. goodalli</i> . Sometimes it is joined anteriorly/abapically to an infraparietal lamella via a transverse bridge (so that the two lamellae form a horseshoe-/U-shaped structure).
5.	parietal lamella	0 = absent 1 = present	An infraparietal lamella is absent or present in <i>A. goodalli</i> and absent in all the other species. Sometimes it is joined anteriorly/abapically to a parietal lamella via a transverse bridge (so that the two lamellae form a horseshoe-/U-shaped structure).
6.	infraparietal lamella	0 = absent 1 = present	A transversely elongate tubercle is sometimes present in the innermost parietum of <i>Gomeziella girottii</i> (Esu, 1978). State 1 is unique to <i>A. goodalli</i> .
7.	parietal tubercle	0 = absent 1 = present	State 2 is unique to <i>A. goodalli</i> . The coding of the character was very difficult. A subcolumnellar lamella is absent in <i>C. lubrica</i> and very evident in <i>A. goodalli</i> but these two states are the extremes of a continuum and many species show wide internal variability.
8.	columnellar lamella	0 = absent 1 = present	A lower palatal denticle/knob/tubercle is absent or present in <i>A. goodalli</i> and absent in all the other species.
9.	subcolumnellar lamella	0 = absent or only slightly evident 1 = evident 2 = clearly evident	State 1 is present in <i>A. goodalli</i> . In <i>G. girottii</i> , at the transition point between the thin and thickened outer peristomal margin, there is sometimes a very subtle knob (in the former species it is clearly evident, whereas in the latter it is faint).
10.	lower palatal knob (tooth-like plica)	0 = absent 1 = present	The coding of the character was very difficult. The outer peristomal margin in lateral view is almost straight in <i>Hypnophila</i> species and very sinuous in <i>A. goodalli</i> but between these two states many situations are subjective and some species show wide internal variability.
11.	upper palatal knob (tooth-like plica)	0 = absent 1 = present	
12.	upper third of the outer peristomal margin	0 = thickened as elsewhere 1 = thinner than elsewhere	
13.	outer peristomal margin in lateral view	0 = almost straight (only slightly sinuous) 1 = sinuous to very sinuous and inverted S-like	



Table 1. continued

No.	Name	Characters		Remarks
		States	States	
14.	rows of pits on protoconch	0 = absent 1 = present		
15.	eye spots	0 = absent 1 = present		
16.	latero-marginal teeth	0 = absent 1 = present		State 1 is unique to <i>A. goodalli</i> .
17.	diverticulum of bursa copulatrix duct	0 = absent 1 = present		State 0 is unique to <i>C. lubrica</i> .
18.	vaginal muff	0 = absent 1 = present		State 0 is unique to <i>C. lubrica</i> .
19.	vas deferens	0 = without evident medial thickening 1 = with evident medial thickening		The calibre of the vas deferens is seldom uniform; however only in <i>Cryptazeca vasconica</i> (Kobelt, 1894) and <i>G. girottii</i> is there a clearly evident medial thickening.
20.	epiphallus/vas deferens	0 = enters penis basally 1 = enters penis laterally		State 1 is unique to <i>Cryptazeca monodonta</i> (De Folin et Bérillon, 1877a).
21.	epiphallus	0 = present 1 = absent		The only slightly enlarged distal portion of vas deferens in <i>Azeca</i> and some <i>Cryptazeca</i> species has sometimes been regarded as an epiphallus (e.g. HESSE 1922, GÓMEZ 1988, 1991).
22.	penis	0 = medium-sized or large, long and cylindrical 1 = small, long and cylindrical 2 = very small, long and cylindrical 3 = short, ovoidal to pear-shaped		State 2 is unique to <i>Hypnophila boissii</i> (Dupuy, 1851) and state 3 to <i>C. monodonta</i> .
23.	muscular sheath on proximal penis	0 = absent 1 = present		State 1 is unique to <i>A. goodalli</i> .
24.	penial appendix	0 = absent 1 = present		State 0 is unique to <i>C. lubrica</i> .
25.	penial diverticulum	0 = absent 1 = present		A penial diverticulum is absent or present in <i>A. goodalli</i> and absent in all the other species.
26.	penial retractor	0 = unbranched 1 = branched		The penial retractor is unbranched or branched in <i>A. goodalli</i> and unbranched in all the other species.
27.	position of penial retractor	0 = lateral 1 = basal/sub-basal		State 0 is unique to <i>C. lubrica</i> and <i>G. girottii</i> .
28.	internal structures at epiphallus/vas deferens opening into penis	0 = conical papilla 1 = cup-like initial portion of one penial plica 2 = apically fringed papilla 3 = absent		
29.	internal penial structures (longitudinal pleats)	0 = absent 1 = present		
30.	internal penial structures (thorned papillae)	0 = absent 1 = present		
31.	internal penial structures (tongue-like structure inside proximal penis)	0 = absent 1 = tongue-like structure 2 = penial bulge		We assumed homology of the tongue-like structures/bulges/ring-shaped sarcobelum inside the proximal penis of <i>Cryptazeca</i> species and <i>Hypnocrania micaelae</i> Cianfanelli et Bodon in Cianfanelli et al., 2018(b) based on their shape and location.



The alignments were performed using the CLUSTAL W programme (THOMPSON *et al.* 1994) implemented in BIOEDIT, version 7.0.5 (HALL 1999). The COI sequences were aligned according to the translated amino acid sequences. The ends of all sequences were trimmed. The lengths of the sequences after cutting were 588 bp for COI, 358 positions for 16S and 748 positions for ITS2. Concatenated COI+16S sequences were of 1,396 positions long (615 COI + 781 ITS2).

RESULTS AND DISCUSSION

AZECID PHYLOGENY BASED ON MORPHOLOGICAL CHARACTERS

Phylogenetic analysis (Fig. 6) had good resolution (only 9 trees with length $L = 2824$; consistency index $CI = 0.95$; retention index $RI = 0.95$; rescaled consistency index $RC = 0.91$) but statistical support was very low (only seven clades were supported, five of them very weakly).

Phylogenetic analysis (Tables 2 and 3) found that most of the species belong to a main clade (MAC – main azecid clade) including *Azeca goodalli* and all species currently assigned to *Hypnophila* except *Hypnophila boissii* (Dupuy, 1851). The nine trees differ in the relationships between MAC, *Gomeziella girottii* and *H. boissii* (Table 3) and in the relationships between *Cryptazeca* species. In the consensus tree MAC has unresolved relationships with *G. girottii* and *H. boissii*. In turn MAC includes two subclades: one with *A. goodalli* and the Dalmatian *Hypnophila* species except *Hypnophila zirjensis* Štamol, Manganeli, Barbato

et Giusti, 2018, the other comprising the remaining western Mediterranean *Hypnophila* species plus *H. zirjensis*. Finally, the group comprising MAC, *G. girottii* and *H. boissii* has sister group relationships with *Cryptazeca* species; in turn this larger group has sister group relationships with *Hypnocarnica micaelae*.

AZECID PHYLOGENY BASED ON MOLECULAR SEQUENCES

CIANFANELLI *et al.* (2018b) published a Bayesian Inference tree of concatenated dataset of three genes (COI, 16S, ITS2) for 16 azecids representative of 12 species (*Azeca goodalli*, *Cryptazeca monodonta* (De Folin et Bérillon, 1877(a)), *C. spelaea* Gómez, 1990(c), *Hypnophila bisacchii* Giusti, 1970, *H. boissii*, *H. dohrni* Paulucci, 1882, *H. etrusca* Paulucci, 1886, *H. malagana* Gittenberger et Menkhorst in Gittenberger, 1983, *H. remyi* Boettger, 1949, *Hypnophila* sp. A, *Hypnophila* sp. B, *Hypnocarnica micaelae*). Their tree of concatenated sequences COI+16S+5.8S+ITS2+28S

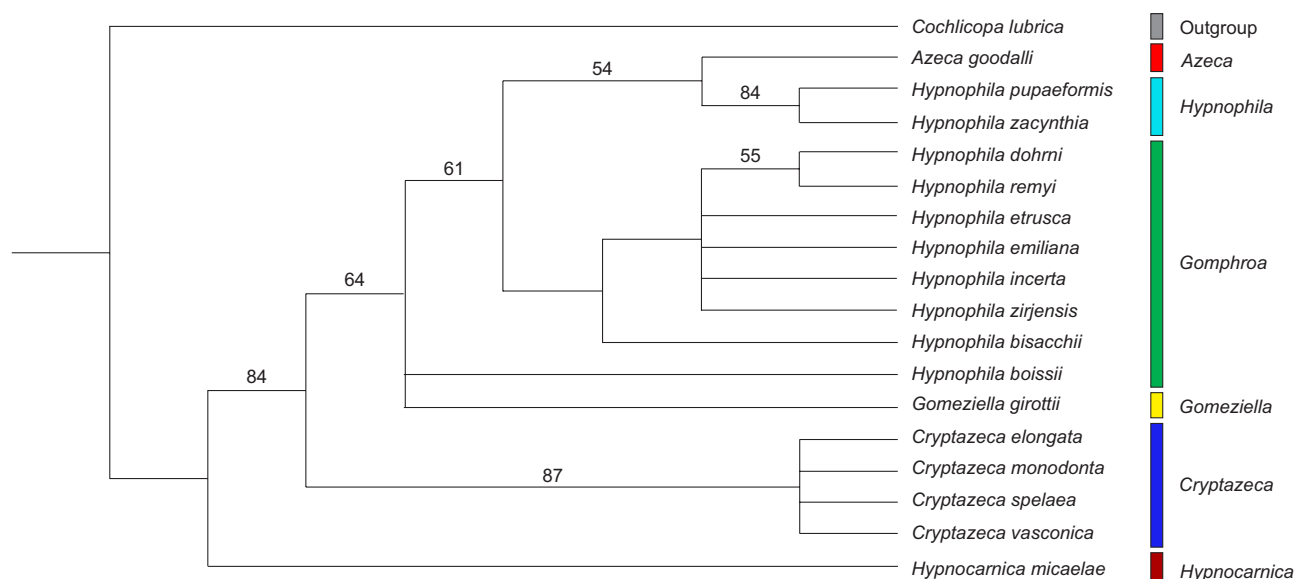

Fig. 6. The strict consensus trees of 9 most parsimonious cladograms generated by the data matrix (Table 2). Numbers next to the branches indicate bootstrap support above 50% calculated for 1,000 replicates (FELSENSTEIN 1985). The tree was rooted with *Cochlicopa lubrica*

Table 2. Character-taxon matrix used for phylogenetic analyses

Taxa/Characters	1	2	3	4	5	6	7	8	9	10	11	12	13	14	15	16	17	18	19	20	21	22	23	24	25	26	27	28	29	30	31					
<i>Cochlicopa lubrica</i>	0	0	0	0	0	0	0	0	0	0	0	0	0	0	0	0	0	0	0	0	0	0	0	0	0	0	0	0	0	0	0	0				
<i>Azeca goodalli</i>	0	1	1	1	0	1	0	1	0	1	0	1	1	0	0	1	1	1	0	0	0	1	0	1	0	0	1	0	1	3	1	0	0			
<i>Cryptazeca elongata</i>	1	1	0	0	0	0	0	0	0,1	0	0	1	1	1	?	?	1	1	0	0	1	0	0	1	0	0	1	0	1	3	0	1	2			
<i>Cryptazeca monodonta</i>	0	1	0	0	0	0	0	0	0	0	0	1	1	1	0	?	1	1	0	1	1	3	0	1	0	0	1	3	0	1	2	0	1	2		
<i>Cryptazeca spelaea</i>	1	1	0	0	0	0	0	0	0,1	0	0	1	1	1	?	?	1	1	0	0	1	0	0	1	0	0	1	3	0	1	2	0	1	2		
<i>Cryptazeca vasconica</i>	0	1	0	0	0	0	0	0	0,1	0	0	1	1	1	?	?	1	1	1	0	1	0	0	1	0	0	1	3	0	1	2	0	1	2		
<i>Gomeziella girottii</i>	2	1	0	0	0	0	0,1	0	0	0	0	1	1	1	1	1	1	1	1	0	1	0	0	1	0	0	0	3	1	0	1	0	0	0		
<i>Hypnophila pupaeformis</i>	3	1	1	0	0	0	0	0	0	0	0	1	0	0	0	0	1	1	0	0	1	0	0	1	0	0	1	1	1	1	0	0	0	0	0	
<i>Hypnophila zacynthia</i>	3	1	1	0	0	0	0	0	0	0	0	1	0	0	?	?	1	1	0	0	1	0	0	1	0	0	1	1	1	1	0	0	0	0	0	
<i>Hypnophila bisacchii</i>	0	1	1	0	0	0	0	0	0	0	0	1	0	0	?	?	1	1	0	0	1	0	0	1	0	0	1	1	1	1	0	0	0	0	0	
<i>Hypnophila boissii</i>	1	1	0	0	0	0	0	0	0	0	0	1	0	1	0	0	1	1	0	0	1	0	0	1	0	0	1	2	1	1	2	1	0	0	0	
<i>Hypnophila dohrni</i>	1	1	1	0	0	0	0	0	0	0	0	1	0	1	0	?	1	1	0	0	1	1	2	0	1	0	0	1	?	1	0	0	0	0	0	
<i>Hypnophila emiliana</i>	1	1	1	0	0	0	0	0	0	0	0	1	0	1	0	?	1	1	0	0	1	1	0	1	0	0	1	2	1	1	2	1	0	0	0	0
<i>Hypnophila etrusca</i>	1	1	1	0	0	0	0	0	0	0	0	1	0	1	0	0	1	1	0	0	1	0	0	1	0	0	1	2	1	1	2	1	0	0	0	0
<i>Hypnophila incerta</i>	1	1	1	0	0	0	0	0	0	0	0	1	0	1	0	0	1	1	0	0	1	0	0	1	0	0	1	2	1	1	2	1	0	0	0	0
<i>Hypnophila renyi</i>	1	1	1	0	0	0	0	0	0	0	0	1	0	1	0	?	1	1	0	0	1	1	0	1	0	0	1	2	1	1	2	1	0	0	0	0
<i>Hypnophila zirjensis</i>	1	1	1	0	0	0	0	0	0	0	0	1	0	1	0	?	1	1	0	0	1	1	0	1	0	0	1	2	1	1	2	1	0	0	0	
<i>Hypnocarnica micaelae</i>	4	1	0	0	0	0	0	0	0	0	0	0	0,1	1	1	1	1	1	0	0	1	0	0	1	0	0	1	3	0	0	1	3	0	0	1	

Polymorphic states (6, 10, 25, 26 in *Azeca goodalli*; 7 in *Gomeziella girottii*; 9 in *Cryptazeca elongata*, *C. spelaea* and *C. vasconica*) were treated as unknown (?) in the analysis.

Table 3. List of main lineages and their auto/synapomorphies

Clades	trees 1, 2, 3 (MAC, BOI, GIR)	trees 4, 5, 6 (MAC, BOI, GIR)	trees 7, 8, 9 (MAC, BOI, GIR)
Azecids	2(1), 13(1), 14(1), 17(1), 18(1), 21(1), 24(1), 27(1)	2(1), 14(1), 17(1), 18(1), 21(1), 24(1), 27(1)	2(1), 14(1), 17(1), 18(1), 21(1), 24(1), 27(1)
<i>Hypnocarnica micaelae</i>	1(4), 15(1), 31(1)	1(4), 15(1), 31(1)	1(4), 15(1), 31(1)
<i>Cryptazeca</i> + <i>Gomeziella girottii</i> + <i>Hypnophila boissii</i> + MAC	12(1), 28(3)	12(1), 28(3)	12(1), 28(3)
<i>Cryptazeca</i>	30(1), 31(2)	13(1), 30(1), 31(2)	13(1), 30(1), 31(2)
<i>Gomeziella girottii</i> + <i>Hypnophila boissii</i> + MAC	29(1)	29(1)	29(1)
<i>Hypnophila boissii</i> + MAC	13(0)		
<i>Gomeziella girottii</i> + <i>Hypnophila boissii</i>	1(3), 15(1), 19(1), 27(0)	1(3), 13(1), 15(1), 19(1), 27(0)	1(3), 13(1), 15(1), 19(1), 27(0)
<i>Gomeziella girottii</i>	1(1), 22(2)	22(2)	1(1), 22(2)
<i>Hypnophila boissii</i>	3(1)	3(1)	3(1)
MAC	14(0)	14(0)	14(0)
<i>Azeca</i> + Dalmatian <i>Hypnophila</i> except <i>Hypnophila zirjensis</i>	4(1), 5(1), 8(1), 11(1), 13(1), 16(1), 23(1)	4(1), 5(1), 8(1), 11(1), 13(1), 16(1), 23(1)	4(1), 5(1), 8(1), 11(1), 13(1), 16(1), 23(1)
<i>Azeca</i>	1(2), 28(1)	1(2), 28(1)	1(2), 28(1)
Dalmatian <i>Hypnophila</i> except <i>Hypnophila zirjensis</i>	28(2)	28(2)	28(2)
Western <i>Hypnophila</i> plus <i>Hypnophila zirjensis</i>			

BOI – *Hypnophila boissii*, GIR – *Gomeziella girottii*, MAC – main azecid clade including *Azeca* and species currently assigned to *Hypnophila* except *H. boissii*.



(CIANFANELLI et al. 2018b: fig. 7) shows phylogenetic relationship of 16 taxa but the list of sequences deposited in GenBank (CIANFANELLI et al. 2018b: tab. 1) contains full set of three genes for only 11 taxa. GenBank resources on azecids are very scanty. Apart from the sequences deposited by CIANFANELLI et al. (2018b) there are only a few sequences of ITS2 deposited by ARMBRUSTER et al. (2005) and MADEIRA et al. (2010). Therefore, we re-examined separately the sequences for COI, 16S and ITS2 deposited in GenBank by CIANFANELLI et al. (2018b) and some ITS2 deposited by MADEIRA et al. (2010) using specified sequences of *Cochlicopa lubrica* as outgroup. Our separate analyses for each gene confirmed that all 12 taxa form one clade in ML trees, as shown by our analysis of morphological characters, whereas the separation of subclades differs for particular genes.

We do not show the Maximum Likelihood (ML) tree of 16S sequences because CIANFANELLI et al. (2018b) did not deposit four sequences of species analysed (i.e. *Cryptazeca spelaea* 1, *C. spelaea* 2, *Hypnophila malagana* 1, *H. malagana* 2) in GenBank.

Molecular phylogenetic analysis based on COI sequences was performed with only 14 COI sequences (Fig. 7) because there were no GenBank deposits for *A. goodalli* 1 and *C. spelaea* 2 (CIANFANELLI et al. 2018b: tab. 1). *Azeca goodalli* seems to be very different from all other azecids and forms a separate subclade. K2P genetic distances between COI sequences indicate that *A. goodalli* differs by 29.1–35.6% from the species representing three other azecid genera (Table 4). Separateness of *Hypnocarnica micaelae* is

also visible (as its K2P values distance it by 21.2–35.6% from other species). All other sequences cluster together in three further subclades, two for species included in *Hypnophila* and one for *Cryptazeca*. K2P distances between COI sequences of species of these genera, i.e. *Cryptazeca* vs. *Hypnophila*, *Cryptazeca* vs. *Hypnocarnica* and *Hypnophila* vs. *Hypnocarnica*, are smaller (16.3–26.4%, Table 4), however they support attribution of particular species to different genera. It is noteworthy that the K2P distance between two different specimens of *Hypnophila malagana* originating from two different Spanish populations is similarly large (16.2%). There is also a very large K2P distance (22.5%) between MG209144 *Hypnophila boissii* and MG209145 *Hypnophila* sp. A (in GenBank named *Hypnophila boissii*), i.e. this large distance differentiates sequences of French (MG209144) and Spanish

Table 4. K2P genetic distances between analysed COI sequences

	K2P distance (%)
Within <i>Azeca</i>	0.0
Within <i>Cryptazeca</i>	10.4–17.4
Within <i>Gomphroa</i>	8.5–22.4
Within <i>Hypnocarnica</i>	0.0
<i>Azeca</i> vs <i>Cryptazeca</i>	31.2–32.2
<i>Azeca</i> vs <i>Gomphroa</i>	29.1–32.8
<i>Azeca</i> vs <i>Hypnocarnica</i>	35.6
<i>Cryptazeca</i> vs <i>Gomphroa</i>	16.3–24.9
<i>Cryptazeca</i> vs <i>Hypnocarnica</i>	21.2–24.9
<i>Gomphroa</i> vs <i>Hypnocarnica</i>	22.6–26.4

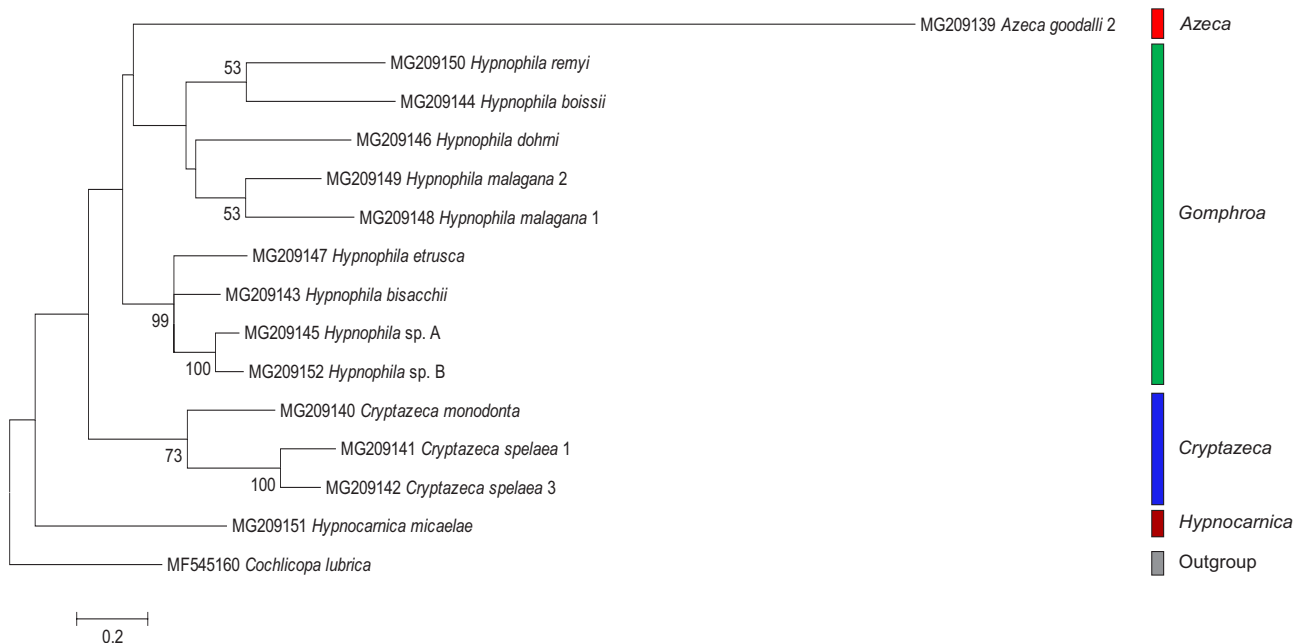

Fig. 7. Maximum Likelihood (ML) tree of COI sequences of Azecidae, based on sequences deposited in GenBank by CIANFANELLI et al. (2018b). Numbers next to the branches indicate bootstrap support above 50% calculated for 1,000 replicates (FELSENSTEIN 1985). The tree was rooted with *Cochlicopa lubrica* sequence MF545160 deposited in GenBank (DEWAARD 2017)

(MG209145) populations of *H. boissii*. Our results therefore support the suggestion of CIANFANELLI et al. (2018b) that French populations of *H. boissii* belong to a different species (probably *Hypnophila etrusca* or a species very close to it). The same is suggested by our analysis of populations of *H. malagana*. Of course, these suggestions must be verified in further anatomical and molecular studies involving a much larger number of individuals of all the populations involved.

The ML tree of ITS2 (Fig. 8) was based on 15 sequences deposited in GenBank by CIANFANELLI et al. (2018b, the sequence for *Hypnophila malagana* 1 is lacking in their table 1). Using four other sequences (AY546470 and FJ791121-FJ791123, obtained from GenBank) we found that a clade with *Azeca goodalli* is separate from the other azecid species in question. Moreover, the sequences from species included in populations of *Hypnophila* from the western Mediterranean clustered separately from those included in *Cryptazeca* and *Hypnocarnica*. The lack of materials prevented study of the molecular relationships between *Gomeziella* and *Hypnophila* from the eastern Mediterranean and other azecid genera.

The ML tree of COI and ITS2 (Fig. 9) was based on these sequences deposited in GenBank by CIANFANELLI et al. (2018b) which allowed to create concatenated COI+ITS2 sequences. The result was similar. *Azeca* was on a very different branch, *Hypnophila* from the western Mediterranean populations clustered separately from those included in *Cryptazeca* and *Hypnocarnica*.

Two final remarks: first, as we stated previously (PIEŃKOWSKA et al. 2019), molecular data alone cannot be used in taxonomic research. Molecular analysis must be supported by morphological features (of shells and/or genital anatomy) before any decision is made about taxonomy or nomenclature. Secondly, mitochondrial COI and 16S as well as nuclear ITS2 gene fragments belong to very variable parts of the genome, and are therefore suitable for studying molecular variation at population or species level. For studies at order or family level, less variable genes are more useful, which is why MADEIRA et al. (2010) excluded ITS2 sequences when studying the position of azecids in the Stylommatophora. They comment as follows: “Sequence variation in the ITS2 region was extremely high, and most of its sites could not be

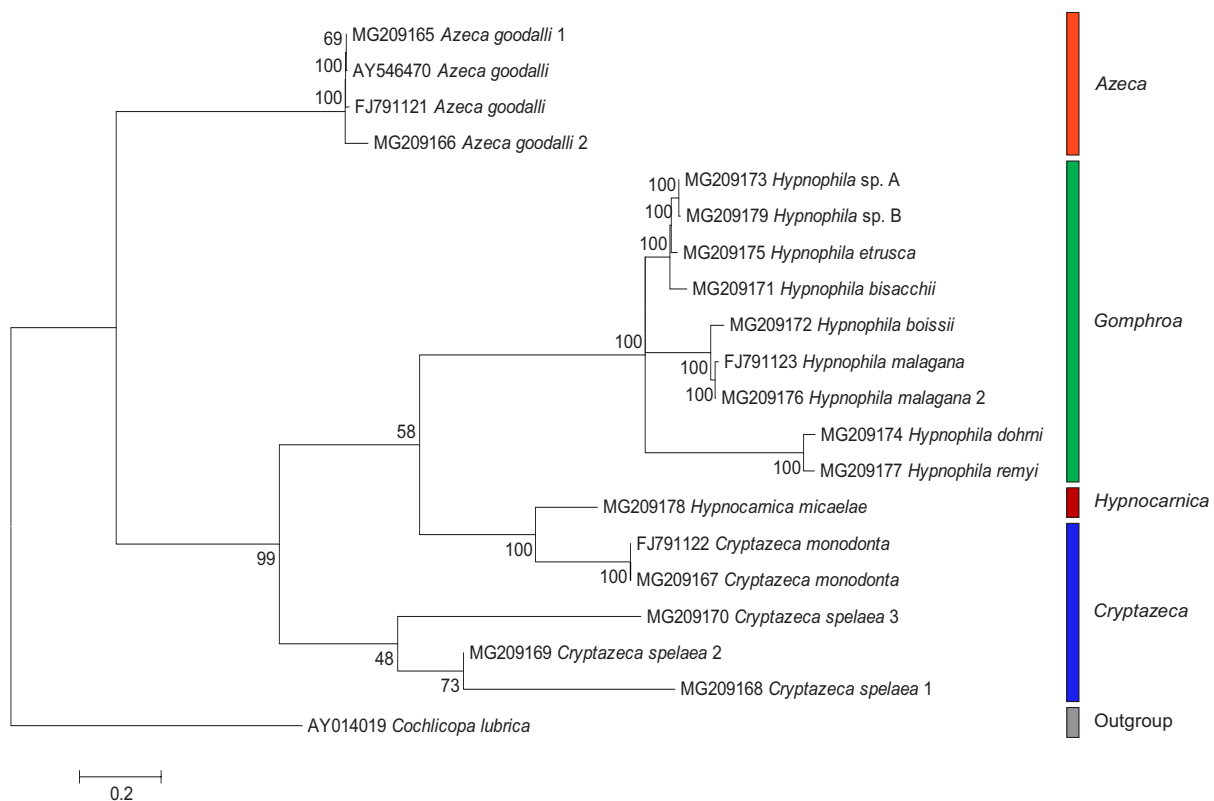

Fig. 8. Maximum Likelihood (ML) tree of ITS2 sequences of Azecidae, based on sequences obtained from GenBank: AY546470 deposited by ARMBRUSTER et al. (2005), FJ791121-FJ791123 by MADEIRA et al. (2010) and MG209165-MG209178 by CIANFANELLI et al. (2018b). Numbers next to the branches indicate bootstrap support above 50% calculated for 1,000 replicates (FELSENSTEIN 1985). The tree was rooted with *Cochlicopa lubrica* sequence AY014019 deposited in GenBank (WADE et al. 2001)

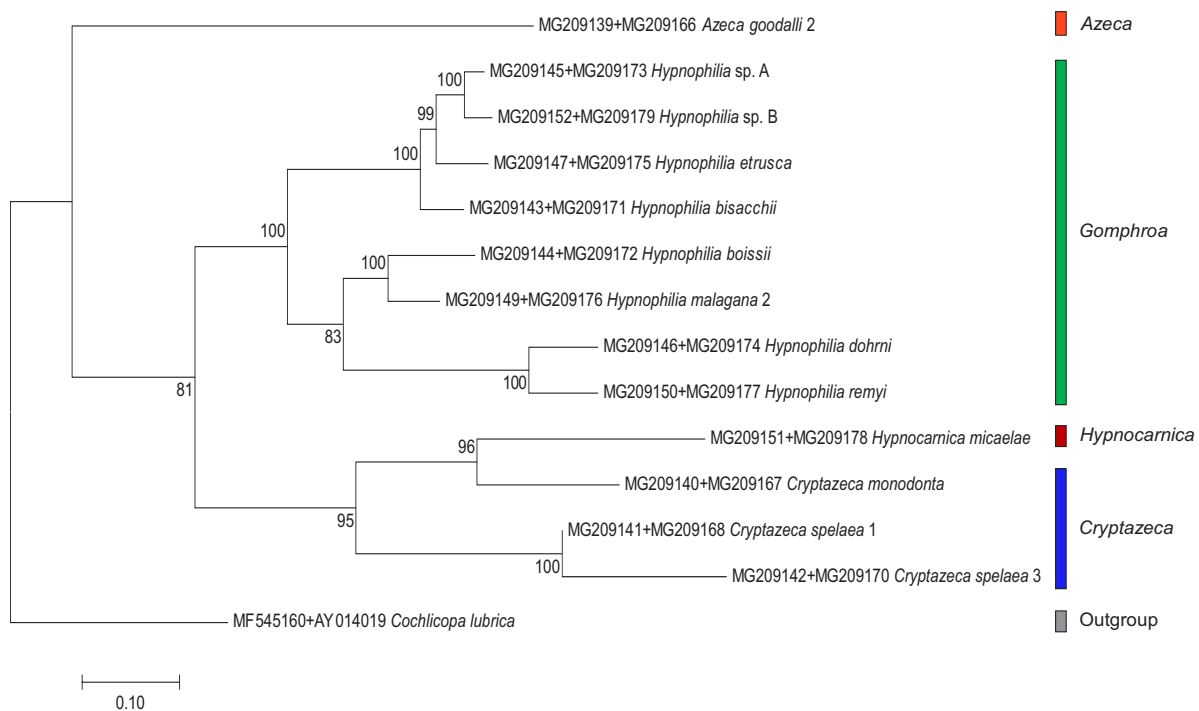

Fig. 9. Maximum Likelihood (ML) tree of concatenated COI+ITS2 sequences of Azecidae, based on sequences obtained from GenBank: MG209139-MG209147, MG209149-MG209152, MG209166-MG209168, MG209170-MG209179 by CIANFANELLI et al. (2018b). Numbers next to the branches indicate bootstrap support above 50% calculated for 1,000 replicates (FELSENSTEIN 1985). The tree was rooted with *Cochlicopa lubrica* concatenated sequence of AY014019 and MF545160 deposited in GenBank by WADE et al. (2001) and by DEWAARD (2017), respectively

aligned when considering all the taxa. Thus, all ITS2 sites were excluded from the phylogenetic analyses.” Certainly molecular studies on the supraspecific classification of the azecids should be continued based on a larger number of analysed taxa and populations as well as more of the analysed nuclear genes.

AZECID SYSTEMATICS: THE STATE OF THE ART

Phylogeny based on morphological characters (Fig. 6) suggests that *Hypnophila* as formerly conceived is a polyphyletic taxon that includes four different lineages: *Gomeziella girottii* (1), *Hypnophila boissii* (2), the Dalmatian *Hypnophila* species except *H. zirjensis* (3); the western Mediterranean species plus *H. zirjensis* (4). Unfortunately molecular studies did not include any species of Dalmatian *Hypnophila* and *Gomeziella girottii* and this biases full comparisons between the two data sets. Moreover, our re-analysis of the molecular data by CIANFANELLI et al. (2018b) produced a somewhat different phylogenetic hypothesis with respect to the original one. Indeed, only the ML tree of COI sequences (Fig. 7) confirmed (with weak bootstrap support) the phylogenetic hypothesis of CIANFANELLI et al. (2018b) that *Hypnocarnica*

micaelae was the sister group to all the other azecids. On the contrary, the ML tree of ITS2 sequences (Fig. 8) as well as the ML tree of concatenated COI+ITS2 sequences (Fig. 9) showed that *Azeca goodalli* was the sister group of all the other azecids, *Cryptazeca* was paraphyletic and *Hypnocarnica micaelae* was the sister group of *Cryptazeca monodonta*. In all the phylogenies, western *Hypnophila* species usually belonged to the same clade, but their internal relationships were variable.

Comparing the results of the two data sets, it emerges that phylogenetic analysis based on morphological characters has good resolution but very low statistical support and that the position of *Hypnophila boissii* is the most variable. This species has unresolved relationships with the main azecid clade and *Gomeziella girottii* in the morphological phylogeny, whereas it is nested in the western *Hypnophila* in the molecular phylogeny.

We think that our molecular results allow a new interpretation of morphological results, therefore we assigned the species now included in *Hypnophila* to two distinct genera: *Gomphroa* including the western species plus *H. zirjensis*; *Hypnophila* including the Dalmatian species except *H. zirjensis*.

SYSTEMATIC REVISION

This section includes a concise survey of all the azecid genera, preceded by a re-description of the family. The genera are listed alphabetically. For each taxon a short diagnosis, a detailed description of the type species and some remarks are given. At the end we also give a re-description of *Hypnocarnica micaelae* followed by some remarks on its systematics.

Family: Azecidae Watson, 1920**Type genus: *Azeca* Fleming, 1828****D i a g n o s i s**

Orthurethran land snails, according to phylogeny based on morphology, characterised by dextral, small, imperforate, elongate shell with whorls almost flat and sutures shallow (2(1)) and rows of pits on protoconch (14(1)); distal genitalia without diverticulum of bursa copulatrix duct (17(1)), epiphallus (21(1)) or penial appendix (24(1)) and with vaginal muff (18(1)) and basal/sub-basal insertion of penial retractor (27(1)). Some taxa lack rows of pits on the protoconch and have additional structures, which replace the true penial papilla, bordering where the vas deferens opens into the penis.

D e s c r i p t i o n

Body: snail-like.

Foot: holopod, undivided.

Jaw: aulacognathe.

Radula: central tooth small, tricuspid; lateral teeth large, bicuspid; latero-marginal teeth absent (*Azeca*) or present (tricuspid, because ectocone split into two); marginal teeth pluricuspid.

Shell: dextral, small (shell height less than 10 mm), imperforate, elongate to very elongate, ovoid-fusiform, ovoid-cylindrical, cylindrical-fusiform, cylindrical-conical, pale-brownish, reddish-brown, yellowish or colourless, glossy and transparent when fresh, with 5 to 10 slightly convex to flat whorls, separated by superficial sutures; aperture orthocline to slightly prosocline, oblique pyriform to ovate pyriform, pointed to rounded at base, with apertural armature very complex to simplified or absent (up to 7–8 pieces: supraparietal, parietal, infraparietal, columellar and subcolumellar lamellae; one or two lower palatal and one upper palatal tooth-like plicae); peristome not reflected, thin in its outer upper third, slightly thickened or thickened elsewhere, sometimes with callous rim on columella and parietum ending in transversely elongate angular tubercle separated by deep notch from upper angle/vertex of aperture and with straight or sinuous (more or less inverted S-like) outer margin; when parietal lamella is present, angular tubercle and upper palatal knob delimit more or

less evident sinus (variably deep furrow may occur at upper angle of aperture between angular tubercle and outer peristome); protoconch smooth or with faint radial crests or close spiral rows of small pits; teleoconch smooth, with very thin spiral grooves and sometimes weak collabral growth lines.

Proximal genitalia (those including parts close to the gonad): the first hermaphrodite duct, talon (seminal receptacle – fertilisation pouch complex), albumen gland and second hermaphrodite duct (or ovispermiduct) do not show significant variation between the various taxa, whereas distal genitalia have very complex and diverse structure.

Female distal genitalia include: free oviduct, bursa copulatrix and its duct and vagina. Free oviduct very short to long and variably wide. Bursa copulatrix sac-like, bean-like, oval or pyriform with long and slender to short and wide duct, initially not flared to very flared. Vagina short to long, variably wide, completely or partially covered by faint to thick, yellowish to brownish muff of “pigmentary cells” (according to GÓMEZ 1991); internal surface smooth or with protuberance covered in small papillae with apical thorns (vaginal part of auxiliary copulatory organ, according to GÓMEZ 1991).

Male distal genitalia include vas deferens and penis. Vas deferens rather long (shorter than FO + V + P) to very long (longer than FO + V + P), more or less uniform in diameter, entering penis basally, sub-basally, laterally or medially; in *Azeca* and *Cryptazeca*, slightly thickened in its proximal and subdistal tract; in *Gomeziella* thickened in its medial section; opening of vas deferens into penis simple (penial papilla absent) or bordered by initial part of one penial pleat or by a papilla consisting of bunch of small, conical appendices fused at base or by a true penial papilla. Penis very short to long, ovoid to pear-shaped or sub-cylindrical or uniformly cylindrical, undivided or divided into distinct proximal and distal parts by slight constriction (*Azeca* and *Hypnocarnica*). In *Azeca* proximal part of penis with or without penial diverticulum and with penial sheath. Penial diverticulum (*Azeca*), when present, very small to small, variable in shape and size (sac-like, elongate straight or hook-like). Penial sheath (*Azeca*) muff-like, enveloping final section of vas deferens and proximal penis, proximally usually continuous with penial retractor and distally ending level with slight constriction; sometimes part of proximal penis and its diverticulum (when present) protrude out of it. Penial retractor arising from diaphragm, inserted basally and sometimes enveloping final section of vas deferens (in *Azeca* continuous with penial sheath and sometimes with thin branch inserted on apex of penial diverticulum) or inserted basally/sub-basally close to or far from vas



deferens or inserted laterally. Internal surface of penis with very small or large longitudinal pleats and/or spongy cordons and accessory structures (thickened parts, knobs, transverse or longitudinal crests) or almost completely covered in small papillae with apical thorns.

R e m a r k s

Within the geographical range of the family, only the orthurethran cochlicopids have a shell similar in shape and size to that of the azecids excluding *Hypnocardica micaelae*. The latter has a shell very similar in shape, size and variation to that of the sigmurethran ferussaciid *Cecilioides* Férussac, 1814, with very slender shells like those of *Cecilioides acicula* (Müller, 1774) and less slender shells like those of *C. petitiana* (Benoit, 1862) / *C. tumulorum* (Bourguignat, 1856) / *C. jani* (De Betta et Martinati, 1855). Again, all the azecids apart from *Hypnocardica micaelae* always have the upper third of the outer peristome thinner than elsewhere. This feature is also detectable in species without a thickened peristome, such as *Gomphroa boissii*. Moreover, many azecids have at least one or two apertural folds/knobs inside the aperture. *Azeca*, *Hypnophila* and *Gomphroa* (excluding *Gomphroa boissii*) also have an angular tubercle. This transversely elongate apertural tubercle is the outermost element of the callous rim which borders the parietum and columella; it is separated from upper angle/vertex of aperture by a deep notch and is not related to the angular lamella (which joins the upper vertex/angle of the outer peristome).

Compared to other orthurethran groups, the azecids have simplified distal genitalia because they lack the diverticulum of the bursa copulatrix duct, the penial appendix and consequently the branch of the penial retractor attached to the penial appendix. The diverticulum of the bursa copulatrix duct and the penial appendix are absent in some unrelated groups of orthurethran snails (families Chondrinidae, Pyramidulidae, Pleurodiscidae, Vertiginidae and so on; SCHILEYKO 1998a, b) and their absence may be regarded as a derived state (BAKER 1935). The presence of the epiphallus is reported in *Azeca* and *Cryptazeca* by HESSE (1922) and GÓMEZ (1988, 1991). However the difference in calibre between the proximal and distal sections of the duct connecting the prostatic ovispermiduct to the penis is really minimal.

The structure of the ovispermiduct is also controversial. GÓMEZ & ANGULO (1990) and GÓMEZ (1991) state that the female ovispermiduct of *Azeca* has an "oviductal caecum" in its proximal region and that the ovispermiduct of *Azeca* and *Cryptazeca* has a "blind-ending duct" in its proximal region, considered to be homologous with the allospermiduct of the other stylommatophorans (GÓMEZ & ANGULO 1990: 109, 110, GÓMEZ 1991: 99). The blind-ending duct was as-

sumed by GÓMEZ & ANGULO (1990) to correspond to the diverticulum described by BOYCOTT (1919). Our light microscope (Wild M5A) study of azecid anatomy failed to find the blind-ending duct (likewise F. Wiegmanns and P. Hesse; see HESSE (1922)) and the oviduct caecum in any of the taxa examined.

The more special anatomical features of azecids are the submedially thickened vas deferens of *Gomeziella girottii*, the penial sheath of *Azeca goodalli* and the stimulator of *Cryptazeca* species. A submedially thickened vas deferens is known in a few other unrelated taxa (e.g. orculids: *Alvariella* Hausdorf, 1996 and *Sphyradium* Charpentier, 1837; see HAUSDORF 1996). Penial sheaths are not identified in other orthurethrans, but this must be considered with caution, because they may have escaped detection during dissection. Finally, the stimulator of *Cryptazeca*, consisting of a vaginal and a penial bulge completely covered in small papillae with apically hooked thorns in the distal genitalia is unique, since similar structures are absent in other orthurethrans (GÓMEZ 1991).

Genus: *Azeca* Fleming, 1828

Figs 10–28

Type species: *Azeca tridens* Fleming, 1828, by monotypy. *Azeca tridens* is a junior synonym of *Helix goodalli* Férussac, 1821. According to ICZN (1999, Art. 11.10), the type species is *Azeca tridens* Fleming, 1828 and not *Turbo tridens* Pulteney, 1799 as stated by Opinion 335 (ICZN, 1953). The type species was indeed established by deliberate misidentification (according to WELTER-SCHULTES 2012: *Helix tridens* Müller, 1774 as misidentified by PULTENEY (1799)).

M a t e r i a l e x a m i n e d

Azeca goodalli (Férussac, 1821) – France, Nouvelle-Aquitaine: Pic de Gillers (department of Pyrénées-Atlantiques), 30TXN8463, B. GÓMEZ leg. 30.10.1987 (4 spirit specimens, 3 dissected, FGC 41647); Sainte-Engrâce (department of Pyrénées-Atlantiques), 30TXN7762, B. GÓMEZ leg. 28.7.1982 (2 spirit specimens, 1 dissected, FGC 41649); Bretagne: Louannec (department of Côte-D'Armor), 30UVV60, M. CALCAGNO & S. CIANFANELLI leg. 30.6.1993 (4 spirit specimens, 3 dissected, SCC 18731); Occitanie: quarry east of Lourdes (department of Hautes-Pyrénées), 30TYN4275, E. BODON & M. BODON leg. 26.2.2010 (10 shells; 2 spirit specimens, 1 dissected, MBC); Lourdes (department of Hautes-Pyrénées), 30TYN47, collector unknown (4 shells, ex Paulucci collection; FGC 19692). Spain, Comunidad Autónoma de Cantabria: Hazas-Asón (municipality of Santander), 30TVN5282, B. GÓMEZ leg. 26.1.1986 (5 spirit specimens, 3

dissected, FGC 41648); Isla (municipality of Santander), 30TVP5414, B. GÓMEZ leg. 26.12.1985 (6 spirit specimens, 2 dissected, FGC 41646). United Kingdom, England: Eversden (county of Cambridgeshire), M. J. BISHOP leg. 27.5.1972 (2 shells, FGC 17207); Paythorne Bridge (county of Lancashire), 30UWE47, D. LINDLEY & A. NORRIS leg. 13.4.2013 (4 spirit specimens, 3 dissected, FGC 41614).

Diagnosis

A genus of the azecids characterised by ovoid-fusiform shell with callous rim on columella and parietum ending in transversely elongate angular tubercle, sinuous (more or less inverted S-like) outer margin with upper third thinner than elsewhere, composite apertural armature (consisting of at least five often knob/fold-like pieces: supraparietal, parietal, columellar lamellae and subcolumellar and upper palatal plicae), and protoconch smooth; radula without latero-marginal teeth; male distal genitalia with vas deferens almost uniform in diameter, penial retractor inserted basally, muscular sheath on proximal penis, no penial papilla at opening of vas deferens into penis and simple longitudinal pleats and poorly discernible cordons inside penis.

Description of type species

Shell (Figs 10–13): dextral, small, imperforate, elongate ovoid-fusiform, reddish-brown, yellowish or colourless, glossy and transparent when fresh, with 7–8 almost flat whorls separated by superficial sutures; aperture orthocone, oblique pyriform, pointed at base, with apertural armature usually consisting of 7–8 parts (small supraparietal lamella; rather high

oblique parietal lamella, sometimes anteriorly joined by transverse bridge to infraparietal lamella forming U-shaped structure; small to very small, sometimes absent, infraparietal lamella; descending columellar lamella; well evident subcolumellar lamella; one or two variably developed, immersed, lower palatal tooth-like plicae; upper palatal tooth-like plica; peristome not reflected, but retracted with respect to last whorl (it seems to form a varix), slightly thickened in its outer upper third and greatly thickened elsewhere, with callous rim on columella and parietum sometimes continuous, evident and ending in transversely elongate angular tubercle separated by deep notch from upper vertex of aperture and with sinuous (more or less inverted S-like) outer margin (parietal lamella, angular tubercle and upper palatal knob delimit more or less evident sinulus); protoconch smooth; teleoconch smooth with very thin spiral grooves. Shell dimensions: H – 6.4–8.0 mm; D – 2.7–2.8 mm.

Body: ocular spots usually present.

Radula: central tooth small, tricuspid; lateral teeth large, bicuspid; latero-marginal teeth absent; marginal teeth pluricuspid (up to 12 cusps) (radular formula: M 16-17/5-12 + L 8-9/2 + C 1/3 + L 8-9/2 + M 16-17/5-12).

Female distal genitalia (Figs 14, 16–19, 23, 26): free oviduct very short to long and variably wide. Bursa copulatrix sac-like, bean-like or pyriform with long and slender to wide duct, initially not flared. Vagina short to long, variably wide, completely or partially (medium-distal portion) covered by usually faint, yellowish to brownish muff; internal surface smooth.

Male distal genitalia (Figs 14–28): vas deferens very long (longer than FO + V + P), almost uniform in diameter (just slightly thickened in its beginning



Figs 10–13. Shells of *Azeca goodalli* (Férussac, 1821): 10–12 – specimens from Lourdes (department of Hautes-Pyrénées), collector unknown; 13 – Eversden (county of Cambridgeshire), M. J. BISHOP leg. 27.5.1972. Scale bar 2 mm

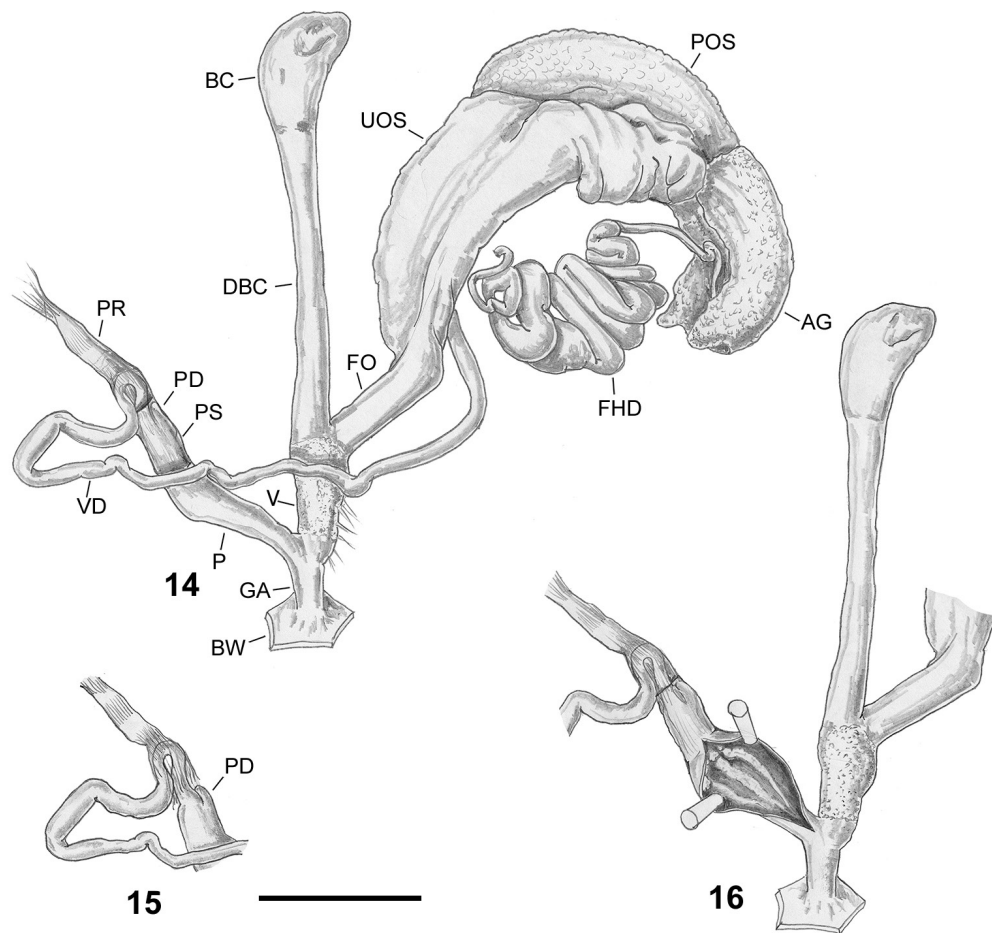

Figs 14–16. Genitalia of *Azeca goodalli* (Férussac, 1821): 14 – general view (gonad excluded); 15 – detail of penial complex; 16 – internal structure of distal penis; a specimen from Paythorne Bridge (county of Lancashire), D. LINDLEY & A. NORRIS leg. 13.4.2013. Scale bar 1 mm

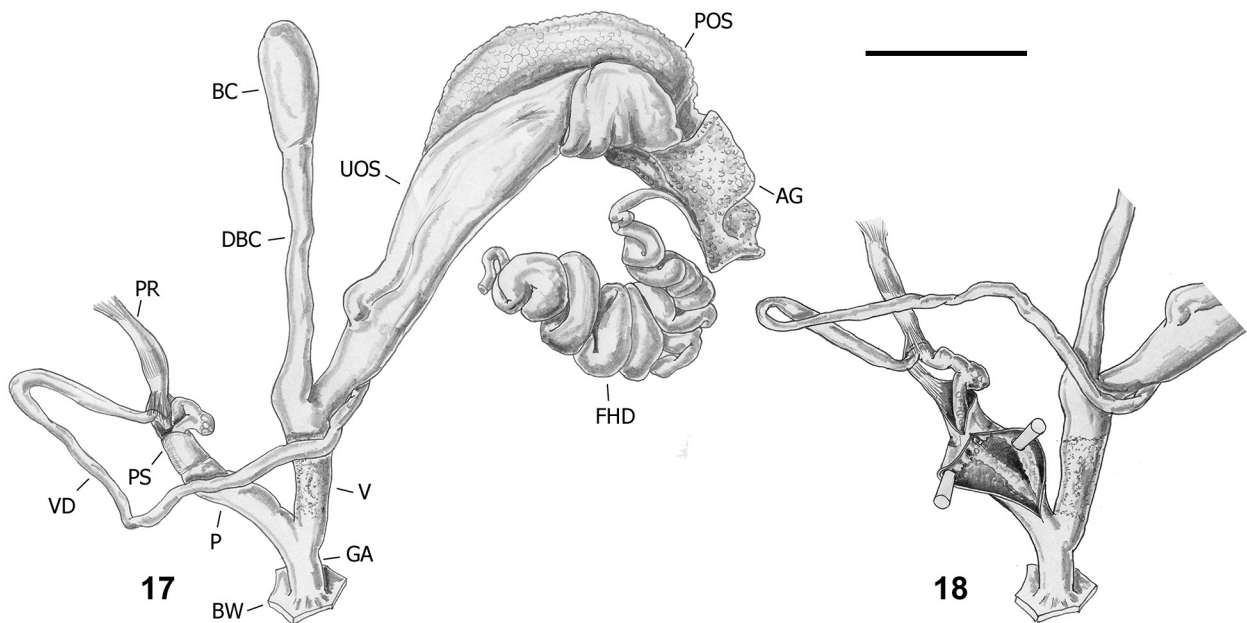

Figs 17–18. Genitalia of *Azeca goodalli* (Férussac, 1821): 17 – general view (gonad excluded); 18 – detail of penial complex and internal structure of distal penis; a specimen from Paythorne Bridge (county of Lancashire), D. LINDLEY & A. NORRIS leg. 13.4.2013. Scale bar 1 mm

and subterminal section), entering penis basally or laterally; opening of vas deferens into penis simple (penial papilla absent). Penis rather long, subcylindrical, divided into distinct proximal and distal parts by slight constriction; proximal part with or without penial diverticulum and with penial sheath. Penial diverticulum, when present, very small to small, variable in shape and size (sac-like, elongate straight or hook-like). Penial sheath muff-like, enveloping final section of vas deferens and proximal penis, proximally usually continuous with penial retractor and ending distally level with slight constriction that divides proximal and distal portions of penis; sometimes part of proximal penis and its diverticulum (when present) protruding out of it. Penial retractor rather short and robust, usually inserted where the vas deferens enters the penis and usually continuous with penial sheath; sometimes thin branch of penial retractor joins apex of penial diverticulum. Internal surface of penis with very small simple longitudinal pleats in proximal portion and some (1–3) poorly visible, low, spongy cordons in distal portion.

R e m a r k s

Azeca was introduced by FLEMING (1828) for a species from the British Isles, *Azeca tridens* Fleming, 1828. It was subsequently regarded as a valid genus with different family allocations: in the sigmurethran

family Ferussaciidae (PILSBRY 1908, HESSE 1922, in the subfamily Cochlicopinae) or in the orthurethran families Pupillidae (WATSON 1920, in the subfamily Azecinae), Cochlicopidae (THIELE 1931, ZILCH 1959, SCHILEYKO 1998a) or Azecidae (BANK et al. 2001).

Phylogeny based on morphological characters (Fig. 6) shows that the monotypic *Azeca*, together with *Hypnophila* and the *Gomphroa* species except *G. boissii*, belongs to the main azecid clade based on the transversely elongate tubercle on the outermost parietum (3(1)); within the main azecid clade *Azeca* is the sister group of two *Hypnophila* species based on loss of rows of pits on the protoconch (14(0)).

Azeca is distinguished by a long series of shell and gross anatomical autapomorphies: supraparietal denticle/tubercle present (4(1)); parietal lamella present (5(1)); columellar lamella present (8(1)); upper palatal denticle/tubercle present (11(1)); outer peristomal margin in lateral view sinuous (inverted S-like) (13(1)); latero-marginal teeth absent (16(1)); muscular sheath on proximal penis present (23(1)).

Molecular phylogenies (Figs 7–9) show that *Azeca* is distant from all the other azecids but its relationships are variable and without support. Unfortunately no molecular data are available on Dalmatian *Hypnophila* and this prevents us from discussing its

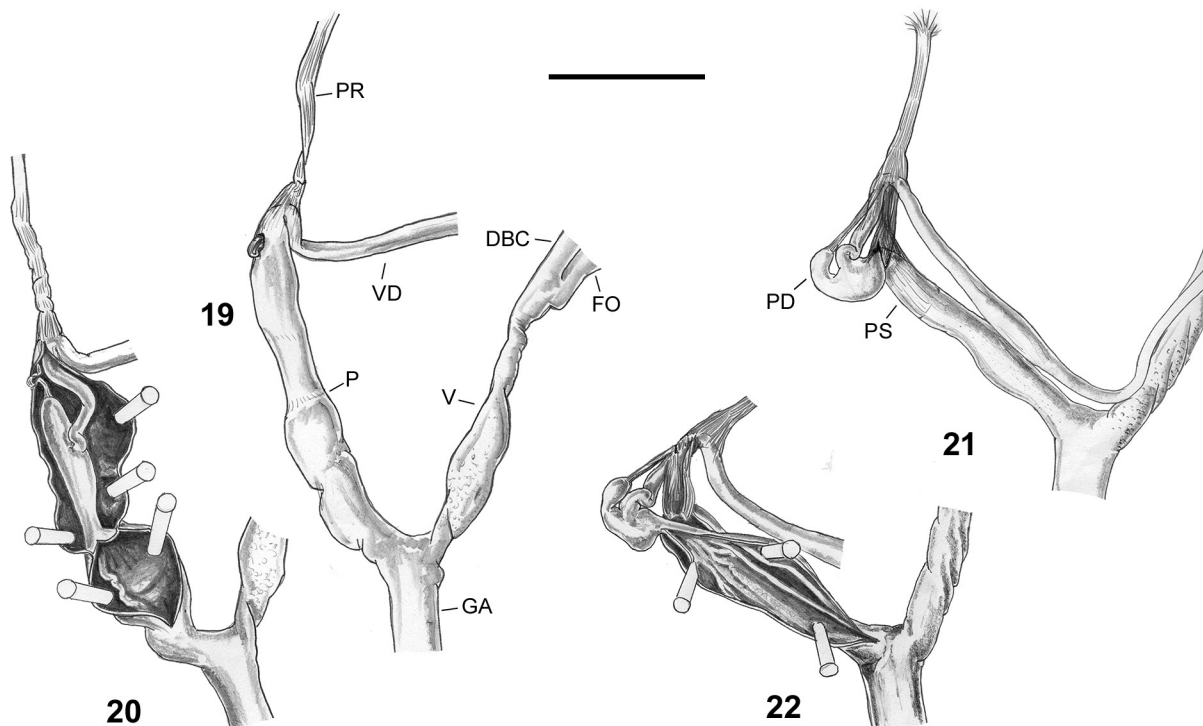

Figs 19–22. Genitalia of *Azeca goodalli* (Férussac, 1821): 19, 21 – distal genitalia; 20, 22 – detail of penial complex and internal structure of distal penis; specimens from Louannec (department of Côte-D’Armor), M. CALCAGNO & S. CIANFANELLI leg. 30.6.1993. Scale bar 1 mm

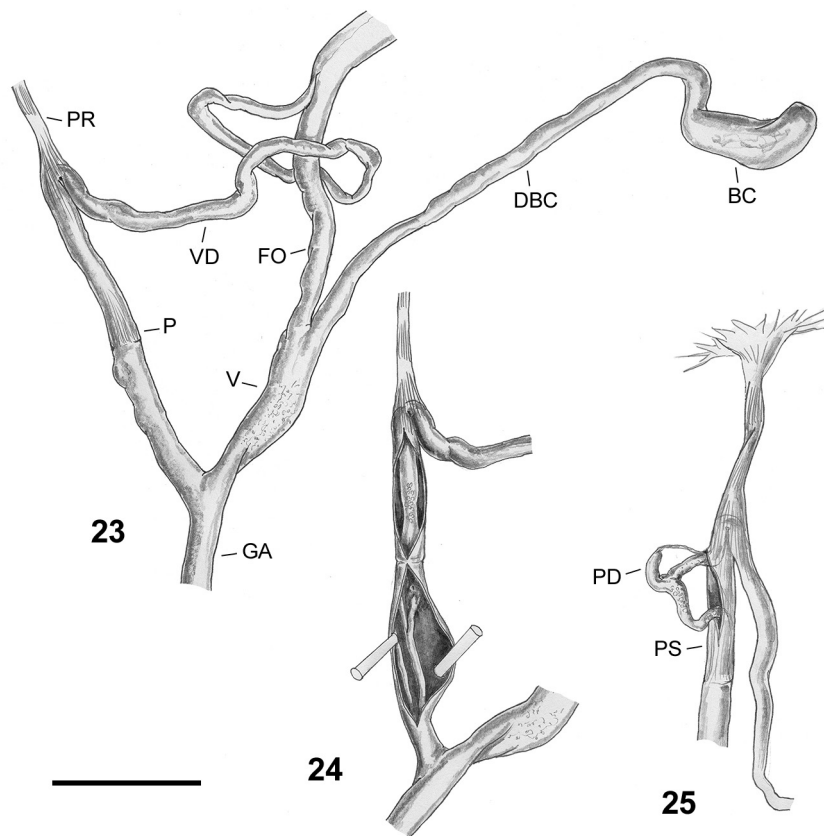

Figs 23–25. Genitalia of *Azeca goodalli* (Férussac, 1821): 23 – distal genitalia; 24–25 – detail of penial complex and internal structure of distal penis; specimens from Pic de Gillers (department of Pyrénées-Atlantiques), B. GÓMEZ leg. 30.10.1987 (23–24) and Isla (municipality of Santander), B. GÓMEZ leg. 26.12.1985 (25). Scale bar 1 mm

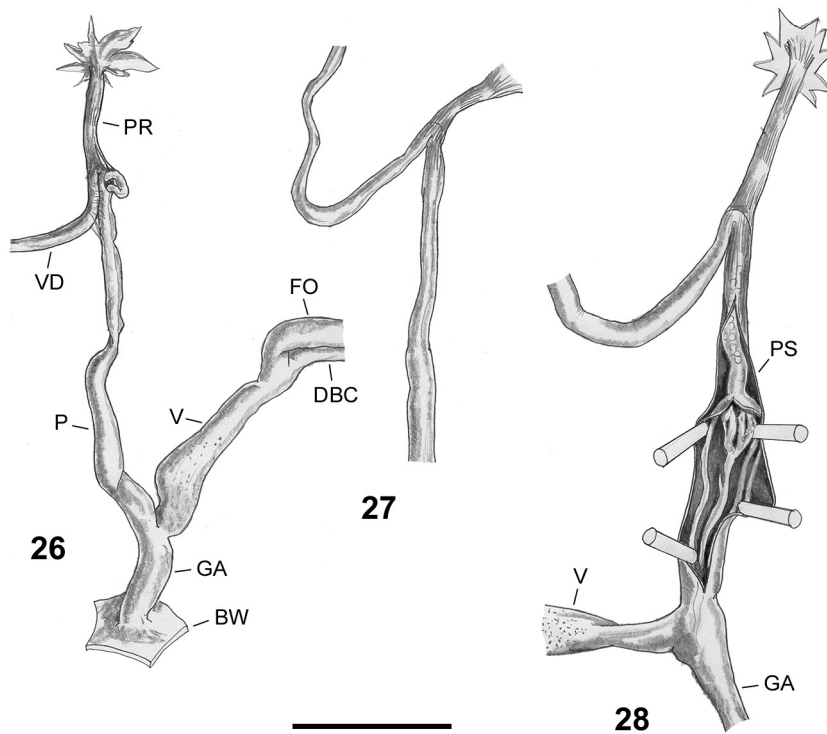

Figs 26–28. Genitalia of *Azeca goodalli* (Férussac, 1821): 26 – distal genitalia; 27–28 – detail of penial complex and internal structure of distal penis; specimens from Hazas-Asón (municipality of Santander), B. GÓMEZ leg. 26.1.1986 (26–27) and Sainte-Engrâce (department of Pyrénées-Atlantiques), B. GÓMEZ leg. 28.7.1982 (28). Scale bar 1 mm

relationships with the genus which are indicated by the phylogeny based on morphological characters.

The genus is monotypic and includes only the widespread *Azeca goodalli* (Férussac, 1821) which occurs in western Europe from Britain eastward to Germany and southward to the northern Iberian Peninsula (KERNEY et al. 1983, WELTER-SCHULTES 2012). The species is little known anatomically and some aspects remain uncertain and controversial (e.g. presence of epiphallus and structure of ovispermiduct): the original contributions are limited to BOYCOTT (1919), HESSE (1922; partly based on Fritz Wiegmanns' research), GÓMEZ (1988) and GÓMEZ & ANGULO (1990). Early anatomical descriptions (BOYCOTT 1919, HESSE 1922) overlooked the penial sheath, which when extended and intact, may conceal the presence of a penial diverticulum.

HESSE (1922) and GÓMEZ (1988, 1991) claimed the existence of an epiphallus, however the difference in calibre between the proximal and distal sections of the duct connecting the prostatic ovispermiduct to the penis is minimal. It is therefore impossible to call it an epiphallus (a similar situation occurs in *Cryptazeca*).

GÓMEZ & ANGULO (1990) and GÓMEZ (1991) stated that further features concern the ovispermiduct, namely a simple fertilisation pouch surrounded by subepithelial goblet gland cells (GÓMEZ 1991: 99); an "oviductal caecum" in the proximal region of

the female ovispermiduct (GÓMEZ & ANGULO 1990: 109, GÓMEZ 1991: 99); a "blind-ending duct" in the proximal region of the ovispermiduct assumed to be homologous with the allospermiduct of the other stylommatophorans (GÓMEZ & ANGULO 1990: 109, 110). A fertilisation pouch with similar structure and a blind-ending duct of the ovispermiduct was also described in *Cryptazeca* (GÓMEZ 1991: 96, 99). The blind-ending duct was considered by GÓMEZ & ANGULO (1990) to correspond to the diverticulum described by BOYCOTT (1919). Our light microscope (Wild M5A) study of azecid anatomy failed to find the blind-ending diverticulum (likewise F. Wiegmanns and P. Hesse; HESSE 1922) or the oviduct caecum in any of the taxa examined.

The shell and anatomical variation of *Azeca goodalli* is remarkable. Shell variation mainly concerns the apertural armature and led to establishment of some variety-level taxa in the early literature (for example, see PILSBRY 1908). Anatomical variations especially concern the proximal part of the penis, with at least five different patterns (Table 5). We do not know if this anatomical variation reflects taxonomic differentiation, artefacts due to pre-mortem stress, or different sexual maturation. However, the fact that some of these patterns coexist within a population suggests that this variation occurs at least partly within populations and does not support the differentiation of species.

Table 5. Anatomical variation in *Azeca goodalli* populations mainly concerns proximal penis, of which there are at least five patterns

	Group 1	Group 2	Group 3	Group 4	Group 5
penis	with diverticulum	with diverticulum	without diverticulum	with diverticulum	without diverticulum
penial retractor	branched: larger branch on distal vas deferens, smaller branch on apex of penial diverticulum	branched: larger branch continuous with penial sheath, smaller branch on apex of penial diverticulum	branched: larger branch continuous with penial sheath, smaller branch on proximal penis	unbranched continuous with penial sheath	unbranched continuous with penial sheath
penial sheath	enveloping part of proximal penis	enveloping proximal penis, but often with lateral cleft from which part of proximal penis and diverticulum protrude	enveloping proximal penis, but with lateral cleft from which part of proximal penis protrudes	enveloping part of proximal penis, including its diverticulum which is thus concealed	enveloping proximal penis, but sometimes with lateral cleft from which part of proximal penis protrudes
populations	Spain: Alisas (GÓMEZ 1988: pl. 3, fig. 3), Aránzasu (GÓMEZ 1988: pl. 3, fig. 5), Hayal de Santiago (GÓMEZ 1988: pl. 3, figs 1–2); ? Germany: Harz (HESSE 1922: pl. 1, fig. 7; pl. 2, fig. 8)	France: Louannec (Figs 19–20, 21–22); Spain: Isla (Fig. 25)	Spain: Hazas-Asón (Fig. 26)	Spain: Kakouetta (GÓMEZ 1988: pl. 3, fig. 4); UK: Paythorne Bridge (Figs 14–16)	Spain: Hazas-Asón; France: Lourdes, Pic de Gillers (Figs 23–24), Saint-Engrâce (Fig. 28); UK: Paythorne Bridge (Figs 17–18)

**Genus: *Cryptazeca* Folin et Bérillon, 1877(b)**

Figs 29–41

Type species: *Azeca monodonta* Folin et Bérillon, 1877(a), by original designation**Material examined**

Cryptazeca monodonta (Folin et Bérillon, 1877(a)) (Figs 29–37) – France, Nouvelle-Aquitaine: Eaux Bonnes (Pyrénées-Atlantiques), B. GÓMEZ leg. 28.10.1987 (4 shells, FGC 48677); Gorges de Kakuetta (Pyrénées-Atlantiques), B. GÓMEZ leg. 21.5.2013 (4 spirit specimens, 2 dissected, FGC 41610); Grottes de Sare (Pyrénées-Atlantiques), 30TXN1591, D. T. HOLYOAK & G. A. HOLYOAK leg. 7.11.2011 (1 spirit specimen dissected, CGAH).

Cryptazeca vasconica (Kobelt, 1894) (Figs 38–41) – Spain, Basque Country: W of Ranero (district of Vizcaya), 30TVN6990, D. T. HOLYOAK & G. A. HOLYOAK leg. 14–15.6.2007 (3 spirit specimens, 2 dissected, CGAH).

Diagnosis

A genus of the azecids characterised by conical/ovoid/slender-fusiform shell with sinuous (more or less inverted S-like) outer margin with upper third thinner than elsewhere, apertural armature only consisting of subcolumellar lamella and protoconch with rows of pits; radula with latero-marginal teeth; male distal genitalia with vas deferens almost uniform in diameter or slightly thickened submedially, penial retractor inserted basally, no muscular sheath on proximal penis, no penial papilla at opening of vas deferens into penis and stimulator consisting of vaginal and penial bulges completely covered in small papillae with apically hooked thorns.

Description of type species

Shell (Figs 29–32): dextral, small, imperforate, elongate ovoid-fusiform, pale brownish to yellowish or colourless, glossy and transparent when fresh, with $5\frac{1}{2}$ – $5\frac{3}{4}$ almost flat whorls separated by superficial sutures; aperture orthocone, oblique pyriform, rounded at base, apertural armature consisting only of evident subcolumellar lamella; peristome not reflected, thin in its outer upper third, slightly thickened elsewhere, continuous, with slightly sinuous (more or less inverted S-like) outer margin; protoconch with close, spiral rows of very small pits in grooves; teleoconch smooth, with or without weak collabral growth lines and with very thin spiral grooves. Shell dimensions: H – 3.1–3.8 mm; D – 1.5–1.7 mm.

Body: ocular spots present.

Radula: central tooth small, tricuspid; lateral teeth large, bicuspid; marginal teeth pluricuspid (FOLIN 1891: figs 1–3 bis) (radular formula unknown).

Female distal genitalia (Figs 33–36): free oviduct short and wide. Bursa copulatrix oval or pyriform with long slender duct, initially very flared. Vagina long and wide, medially covered by thick, brownish muff. Internally protuberance covered in small papillae with apical thorns (vaginal part of auxiliary copulatory organ, according to GÓMEZ 1991) where free oviduct and duct of bursa copulatrix join vagina.

Male distal genitalia (Figs 33–37): vas deferens rather long, uniform in diameter (thin for its entire length), entering penis medially on small protuberance (considered “a short and rudimentary epiphallus” by GÓMEZ 1991); opening of vas deferens into penis simple (penial papilla absent). Penis short, ovoid to pear-shaped, undivided, without penial sheath and penial diverticulum. Penial retractor very short and robust, inserted basally. Internal surface of penis with bulge completely covered in small papillae



Figs 29–32. Shells of *Cryptazeca monodonta* (De Folin et Bérillon, 1877 (a)), specimens from Eaux Bonnes (department of Pyrénées-Atlantiques), B. GÓMEZ leg. 28.10.1987. Scale bar 2 mm

with apically hooked thorns (ring-shaped stimulatory organ according to GÓMEZ & ANGULO 1987 and GÓMEZ 1990b, c; ring-shaped sarcobelum according to GÓMEZ 1991).

Remarks

Cryptazeca was established by FOLIN & BÉRILLON (1877b) for a species from the Pyrénées-Atlantiques, France. It was regarded as a valid distinct genus in the sigmurethran families Ferussaciidae (e.g. PILSBRY 1908, HESSE 1922, GERMAIN 1930, THIELE 1931, ZILCH 1959, BANK et al. 2001, SCHILEYKO 1999, in the subfamily Cryptazecinae) or Subulinidae (GITTENBERGER 1983) by all subsequent authors. In the late 1980s, GÓMEZ & ANGULO (1987) showed that its type-species had an orthurethrous kidney, so they moved the genus to the orthurethran family Cochlicopidae. Subsequently MADEIRA et al. (2010) re-examined its relationships with the genera *Azeca*, *Cochlicopa*, *Ferussacia* and *Hypnophila* based on rRNA

gene-cluster. They found that *Cryptazeca* belonged to a clade distinct from the one including *Cochlicopa*. Indeed *Cryptazeca* groups with *Azeca* and *Hypnophila* to form a clade which has unresolved relationships with the chondrinids and with a large assemblage including all the orthurethran genera examined. On the contrary *Cochlicopa* groups with the Hawaiian amastrid *Leptachatina* Gould, 1848, forming a clade nested in the large orthurethran assemblage, with sister group relationships to the valloniids but without statistical support.

Phylogeny based on morphological characters (Fig. 6) shows that *Cryptazeca* species constitute a supported clade characterised by at least three autapomorphies, namely sinuous outer peristomal margin in lateral view (13(1)), penial bulge (31(1)) completely covered in small papillae with apically hooked thorns (30(1)). In turn *Cryptazeca* has sister group relationships with the clade consisting of *Gomeziella girottii*, *Gomphroa boissii* and the main azecid clade

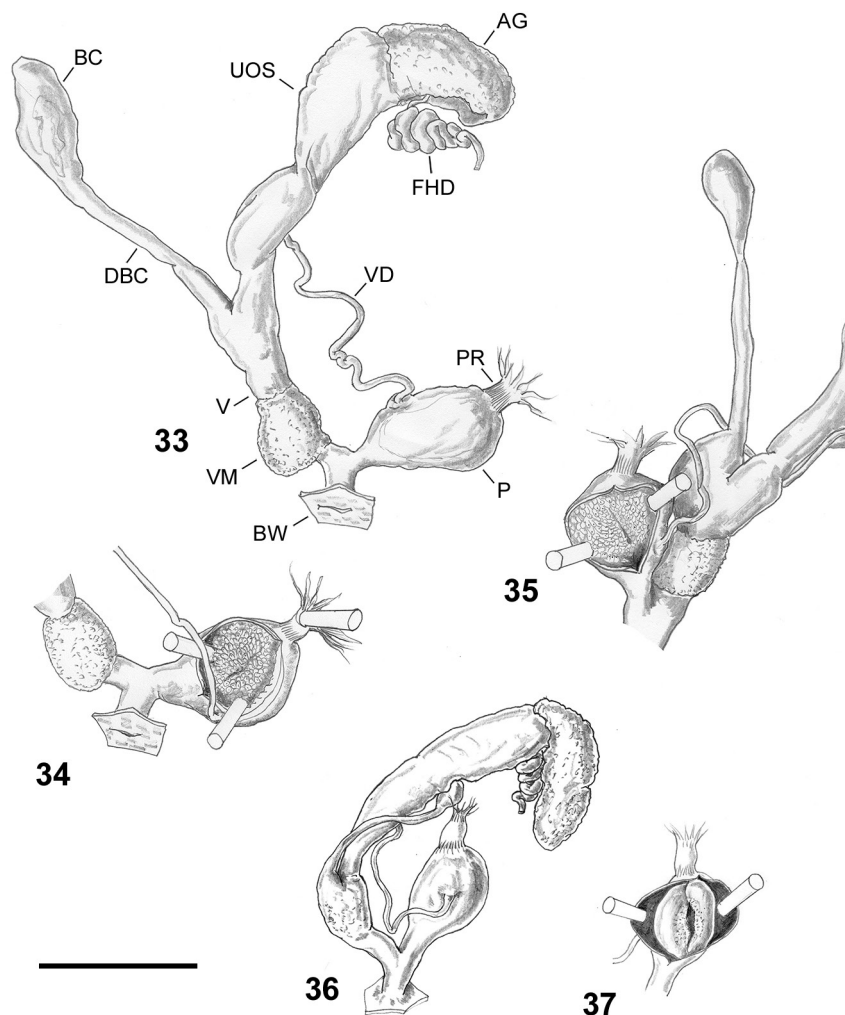

Figs 33–37. Genitalia of *Cryptazeca monodonta* (De Folin et Bérillon, 1877(a)): 33, 36 – general view (gonad excluded); 34–35, 37 – internal structure of penis; specimens from Gorges de Kakuetta (Pyrénées-Atlantiques), B. GÓMEZ leg. 21.5.2013 (33–35) and Grottes de Sare (Pyrénées-Atlantiques), D. T. HOLYOAK & G. A. HOLYOAK leg. 7.11.2011 (36–37). Scale bar 1 mm

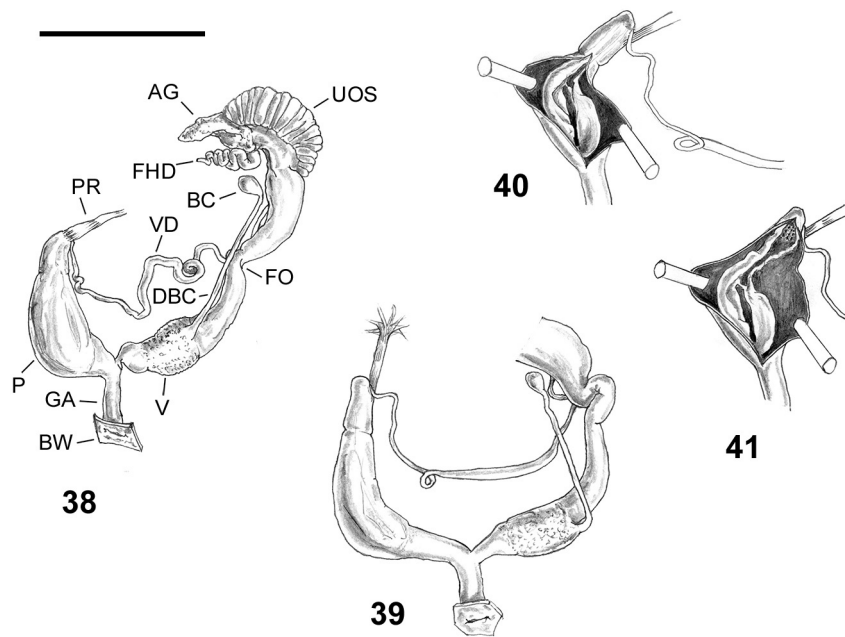

Figs 38–41. Genitalia of *Cryptazeca vasconica* (Kobelt, 1894): 38, 39 – general view (gonad excluded); 40–41 – internal structure of penis; specimens from W of Ranero (province of Vizcaya, Basque Country), D. T. HOLYOAK & G. A. HOLYOAK leg. 14–15.6.2007. Scale bar 1 mm

(*Azeca goodalli* and all the species currently assigned to *Hypnophila*), sharing at least two synapomorphies: upper third of outer peristome thinner than elsewhere (12(1)) and absence of a true penial papilla (28(3)).

The ML tree based on COI sequences (Fig. 7) suggests that *Cryptazeca* species form a clade separate from the *Azeca* plus *Gomphroa* group and from *Hypnocarnica micaelae*. On the contrary, the ML tree of ITS2 sequences (Fig. 8) shows that *Cryptazeca* is paraphyletic: *Cryptazeca monodonta* forms a clade with *H. micaelae* and the group has sister relationships with *Gomphroa*; in turn the larger group (*C. monodonta*, *H. micaelae* and *Gomphroa*) has sister group relationships with *Cryptazeca spelaea*. What is more, in the ML tree of concatenated COI+ITS2 sequences (Fig. 9) *C. monodonta* clusters together with *H. micaelae* and in the larger group with *C. spelaea* forms a sister clade to *Gomphroa*.

As in *Azeca*, the presence of an epiphallus and the structure of the ovispermiduct remain unclear. The epiphallus is absent in *C. monodonta* and *C. vasconica* according to GÓMEZ & ANGULO (1987); a rudimentary epiphallus is present in *C. monodonta* according to GÓMEZ (1991); a normal but only slightly developed epiphallus is present in *C. spelaea* and *C. elongata* (GÓMEZ 1990b, c). However the calibre difference between the proximal and distal sections of the duct connecting the prostatic ovispermiduct to the penis is minimal. It is therefore impossible to call it an epiphallus. According to GÓMEZ (1991), the ovispermiduct has a “blind-ending duct” that opens proximally into the free oviduct; this duct is assumed to be similar to that reported in *Azeca* and considered homologous to

the allospermiduct of the other stylommatophorans by GÓMEZ & ANGULO (1990). However we failed to find it during our light microscope study (Wild M5A) of some specimens of *Cryptazeca monodonta*.

The penial bulge completely covered in small papillae with apically hooked thorns distinguishes *Cryptazeca* sharply from all the other azecid genera. However, homology based on shape and location may be postulated between the penial bulge of *Cryptazeca* species and the tongue-like structure in the proximal penis of *Hypnocarnica micaelae*.

Apart from the type species, *Cryptazeca* includes three other species: *C. elongata* Gómez, 1990(b), *C. spelaea* Gómez, 1990(c), and *C. subcylindrica* Folin et Bérillon, 1877(b) (HOLYOAK & HOLYOAK 2012, WELTER-SCHULTES 2012). However, the status of certain allopatric taxa synonymised by HOLYOAK & HOLYOAK (2012), based only on conchological characters, deserves further research (*C. kobelti* Gittenberger, 1983; *C. vasconica* (Kobelt, 1894)). Some species are known anatomically (*C. elongata*; *C. monodonta*, *C. spelaea*, *C. vasconica*; see: GÓMEZ & ANGULO 1987, GÓMEZ 1990a, b, 1991). *Cryptazeca* species differ anatomically by virtue of the insertion of the vas deferens into the penis (lateral on a small protuberance in *C. monodonta*; basal and simple in the other species), the vaginal muff (well developed in *C. monodonta*; only slightly developed in the other species), the vaginal part of the auxiliary copulatory organ (present in *C. monodonta*; absent in the other species?), the shape of the penial auxiliary copulatory organ (wider in *C. monodonta*; narrower in *C. spelaea*) and thorn shape (hooked in *C. monodonta*; not

hooked in *C. elongata* and *C. spelaea*); other differences concern vagina length and penis shape but it is difficult to state if they are true differences or due to different sexual maturation or artefacts of pre-mortem stress (see for example GÓMEZ 1990b: figs 9 and 11).

Genus: *Gomeziella* Cianfanelli, Bodon, Giusti et Manganelli, 2018(a)

Figs 42–49

Type species: *Hypnophila girottii* Esu, 1978

Material examined

Gomeziella girottii (Esu, 1978) – Italy, Sardinia: Codula Fuili (province of Nuoro), 32TNK5256, S. CIANFANELLI & E. TALENTI leg. 19.5.2004 (126 shells, 3 spirit specimens, 2 dissected, MZUF GC/21905; 3 spirit specimens, 2 dissected, MZUF GC/21928); Punta Pedra Longa (province of Ogliastra), 32TNK6031, A. MARGELLI leg. 27.5.2013 and 21.6.2013 (93 shells, AMC; 2 specimens, 1 dissected, MZUF GC/43136, GC/43137); State Road 129, near San Leonardo, between Onifai and Orosei (province of Nuoro), 32TNK5671, S. CIANFANELLI & E. TALENTI leg. 27.10.1995 (85 shells, MZUF GC/42228; 4 shells, SCC).

Diagnosis

A genus of the azecids characterised by very elongate, cylindrical to conical shell with sinuous (more or less inverted S-like) outer margin with upper third thinner than elsewhere, simplified apertural armature (consisting only of small, faint, often absent tubercle

on innermost parietum and subcolumellar lamella) and protoconch with rows of pits; radula with latero-marginal teeth; male distal genitalia with vas deferens thickened submedially, penial retractor inserted laterally, no muscular sheath on proximal penis, no penial papilla at opening of vas deferens into penis and longitudinal pleats, one crest-like, inside penis.

Description of type species

Shell (Figs 42–46): dextral, small, imperforate, elongate to very elongate, cylindrical-conical or cylindro-fusiform, colourless, glossy and transparent when fresh, with 7½–10 slightly convex to flat whorls, separated by superficial sutures; aperture slightly prosocline, oblique pyriform, rounded at base, with simplified apertural armature (consisting of only small, faint, often absent, tubercle on innermost parietum and barely evident subcolumellar lamella); peristome not reflected, thin in outer upper third, slightly thickened elsewhere (point of passage sometimes knob-like) and more or less continuous, with sinuous (more or less inverted S-like) outer margin; protoconch with close, spiral rows of very small pits in grooves; teleoconch smooth, with very thin spiral grooves. Shell dimensions: H – 4.0–6.8 mm; D – 1.2–1.9 mm.

Body: ocular spots absent.

Radula: central tooth small, tricuspid; lateral teeth large, bicuspid; latero-marginal tooth tricuspid (because ectocone split into two); marginal teeth pluricuspid (up to 9 cusps) (radular formula: M ca. 10/4-9 + LM 1/3-4 + L 3/2 + C 1/3 + L 3/2 + LM 1/3-4 + M ca. 10/4-9).

Female distal genitalia (Figs 47–49): free oviduct short to long and variably wide. Bursa copulatrix



Figs 42–46. Shells of *Gomeziella girottii* (Esu, 1978), specimens from Punta Pedra Longa (province of Ogliastra), A. MARGELLI leg. 27.5.2013 and 21.6.2013. Scale bar 2 mm

bean-like or pyriform with long to very long, very slender duct, initially barely flared. Vagina long and rather slender, proximally covered by faint yellowish muff; internal surface smooth.

Male distal genitalia (Figs 47–49): vas deferens very long (longer than FO + V + P), uneven in diameter (thin for entire length except for submedial section which is markedly thickened) entering penis basally (subterminal section not enveloped by penial retractor); opening of vas deferens into penis simple (penial papilla absent). Penis long, subcylindrical (wider medio-distally and tapering distally), undivided, without penial sheath or penial diverticulum. Penial retractor short and robust, inserted laterally at about first third of penis length. Internal surface of proximal penis with two longitudinal pleats: one pleat with jagged edges continues uninterrupted for entire length of penis; the other pleat sometimes branches in two level with point of insertion of penial retractor; these two pleats continue for part or entire length of distal penis (one of the latter two is sometimes higher, sinuous and crest-like).

Remarks

Gomeziella girottii does not belong to the ferusaciids, contrary to the claim of WELTER-SCHULTES (2012): its orthurethrous kidney definitively excludes this possibility.

Phylogeny based on morphological characters (Fig. 6) shows that the species is characterised by at least five autapomorphies, namely very elongate, cylindrical-conical or cylindrical-fusiform shell (1(3)), sinuous outer peristomal margin in lateral view (13(1)), eye spots absent (15(1)), vas deferens well thickened submedially (19(1)) and lateral insertion of penial retractor (27(0)); in turn *G. girottii* has unresolved relationships with *Gomphroa boissii* and the main azecid clade including *Azeca* and all the species currently assigned to *Hypnophila*. This group (*Gomeziella girottii*, *Gomphroa boissii* and the main azecid clade) shares at least one synapomorphy: the penial longitudinal pleats (29(1)).

One of the most peculiar features of *G. girottii* is a submedially well thickened vas deferens. A similar vas deferens structure is known in few other unrelat-

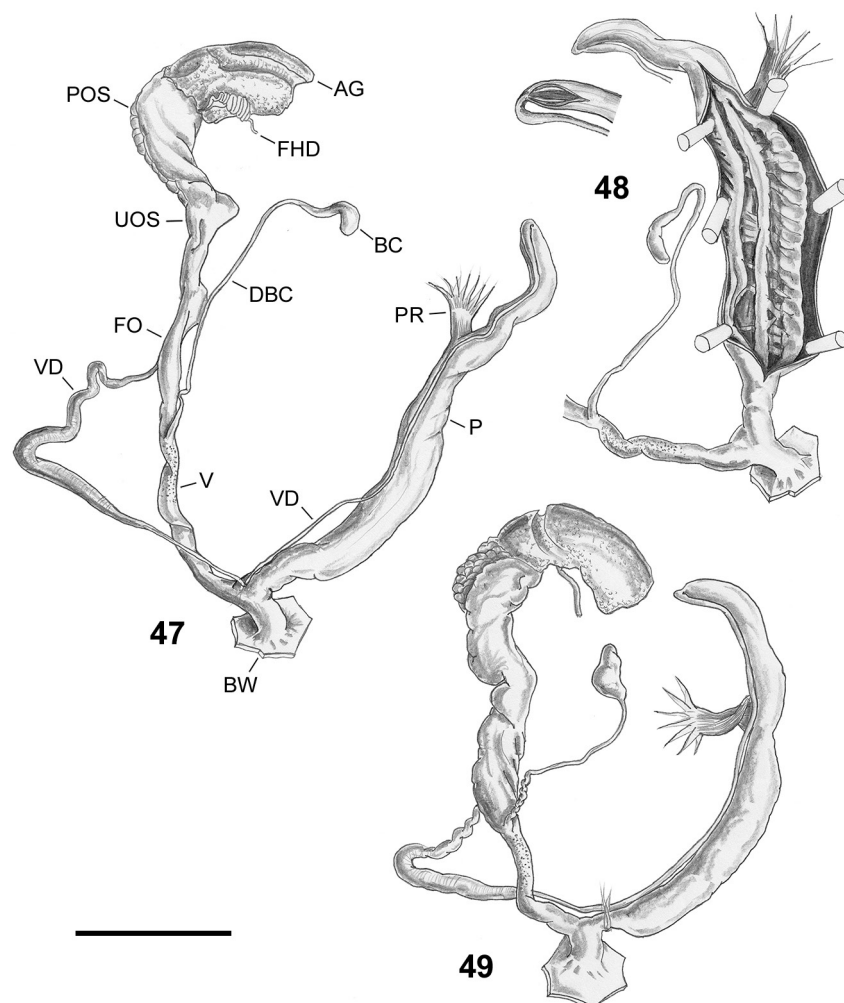

Figs 47–49. Genitalia of *Gomeziella girottii* (Esu, 1978): 47, 49 – general view (gonad excluded); 48 – internal structure of penis; specimens from Codula Fuili (province of Nuoro), S. CIANFANELLI & E. TALENTI leg. 19.5.2004. Scale bar 1 mm

ed taxa (e.g. orculids: *Alvariella* Hausdorf, 1996 and *Sphyradium* Charpentier, 1837; see HAUSDORF 1996).

The new genus includes only one species from Sardinia (western Mediterranean). Its populations vary in shell shape and size, but it is still unclear whether this variation reflects taxonomic differentiation.

Genus: *Gomphroa* Westerlund, 1902

Figs 50–80

Type species: *Zua boissii* Dupuy, 1851, by monotypy

Material examined

Gomphroa boissii (Dupuy, 1851) (Figs 50–54) – France, Provence-Alpes-Côte-d’Azur: Callelongue (department of Bouches-du-Rhône), 31TFH9186, M. BODON leg. 30.12.1989 (7 shells, MBC); Spain, Cataluña: Collserola, Ermita de Sant Vicenç (province of Barcelona), V. BROS leg. 8.2002 (2 spirit specimens dissected; FGC 41611); Las Planas de Vallvidrera (province of Barcelona), C. ALTIMIRA leg. 4.1956 (3 shells, FGC 16563); Les Teixoneres (province of Barcelona), J. COMAS NAVARRO leg. 9.9.2002 (2 shells, MZB 2009-0646); Parc Natural de Sant Llorenç del Munt (province of Barcelona), V. BROS leg. 2.2013 (1 spirit specimen dissected, FGC 41615); Queralt (province of Barcelona), G. GARDINI leg. 22.7.1990 (1 spirit specimen dissected, FGC 41617).

Gomphroa dohrni (Paulucci, 1882) (Figs 55–58) – Italy, Sardinia: Costa Dorata (province of Olbia-Tempio Pausania), 32TNL5524, S. CIANFANELLI & E. LORI leg. 1.5.2003 (2 spirit specimens, 1 dissected, MZUF GC/7573); Monte Nieddu (prov-

ince of Carbonia-Iglesias), collector unknown leg. 23.3.1976 (1 spirit specimen dissected, FGC 29598); Orroli (province of Cagliari), 32SNJ29, L. PINTÉR leg. 2.4.1978 (3 spirit specimens, 1 dissected, FGC 29596).

Gomphroa cf. *remyi* (Boettger, 1949) (Figs 59–61) – France, Corsica: Cap Corse, Camera, 32TNN2956, S. TAITI leg. 18.4.1981 (1 spirit specimen, FGC 29615); Cap Corse, Pietra Nera, 32TNN3730, L. CASTAGNOLO, F. GIUSTI & G. MANGANELLI leg. 4.12.1983 (3 spirit specimens, 2 dissected, FGC 29624).

Gomphroa bisacchii (Giusti, 1970) (Figs 62–65) – Italy, Sardinia: Cala Gonone (province of Nuoro), 32TNK55, F. GIUSTI leg. 2.5.1969 (1 shell [holotype], 2 spirit specimens [paratypes] dissected, FGC 9290, 19648); Cala Gonone, Codula Fuili (province of Nuoro), 32TNK5356, S. CIANFANELLI & E. TALENTI leg. 19.5.2004 (6 spirit specimens, 2 dissected, MZUF GC/21929); Dorgali (province of Nuoro), 500–600 m a.s.l., 32TNK56, L. PINTÉR leg. 5.4.1978 (7 shells, FGC 16561; 9 spirit specimens, 2 dissected, FGC 29591); Dorgali (province of Nuoro), 32TNK56, collector unknown leg. 22.5.1980 (11 spirit specimens, 2 dissected, FGC 29590).

Gomphroa etrusca (Paulucci, 1886) (Figs 66–68) – Italy, Tuscany, Monte Argentario (province of Grosseto): Porto Santo Stefano, not georeferenceable, collector and date unknown (1 spirit specimens, 1 dissected, FGC 16908); cemetery of Porto Santo Stefano, 32TPM7499, V. SBORDONI leg. 29.4.1978 (1 spirit specimen dissected, FGC 16909).

Gomphroa cf. *etrusca* (Paulucci, 1886) (Figs 69–72) – Italy, Tuscany, Tuscan Archipelago: Island of Giglio (province of Grosseto), Il Franco, 32TPM59, L.



Figs 50–53. Shells of *Gomphroa boissii* (Dupuy, 1851), specimens from Les Teixoneres (province of Barcelona), J. COMAS NAVARRO leg. 9.9.2002 (50–51) and Las Planas de Vallvidrera (province of Barcelona), C. ALTIMIRA leg. 4.1956 (52–53). Scale bar 2 mm



FAVILLI & G. MANGANELLI leg. 21.2.1990 (10 shells, FGC 5015), A. BENOCCI, F. GIUSTI & G. MANGANELLI leg. 27.2.2013 (6 shells, 2 spirit specimens dissected, FGC 40920); Island of

Gorgona (province of Livorno), Torre Vecchia, F. GIUSTI leg. 31.3.1974 (2 spirit specimens dissected, FGC 16899).

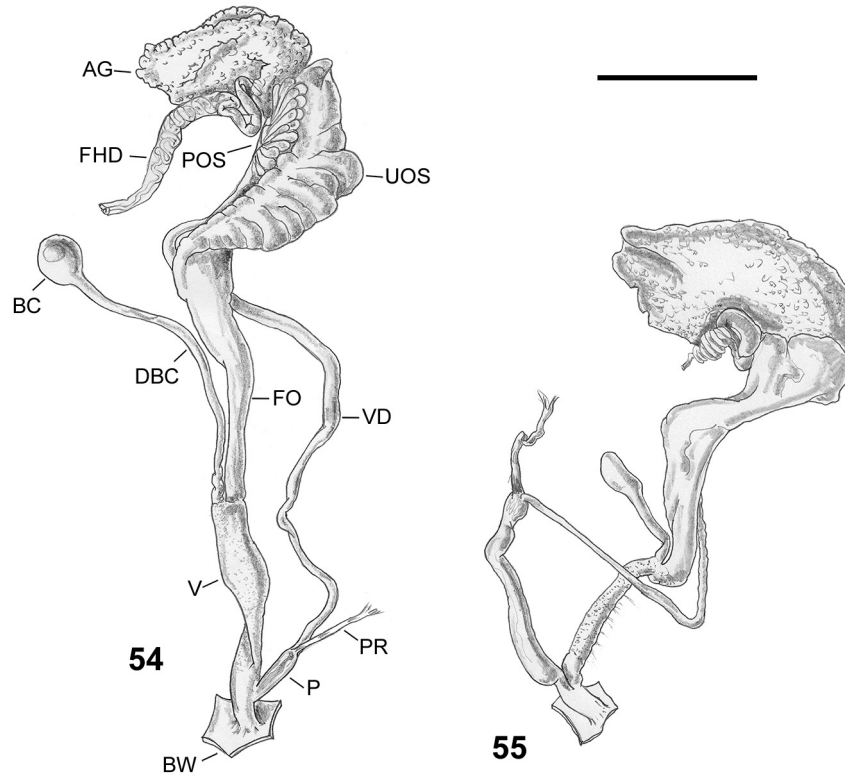

Figs 54–55. Genitalia (gonad excluded) of: 54 – *Gomphroa boissii* (Dupuy, 1851), specimens from Collserola, Ermita de Sant Vicenç (province of Barcelona), V. BROS leg. 8.2002; 55 – *Gomphroa dohrni* (Paulucci, 1882) from Costa Dorata (province of Olbia-Tempio Pausania), S. CIANFANELLI & E. LORI leg. 1.5.2003. Scale bar 1 mm

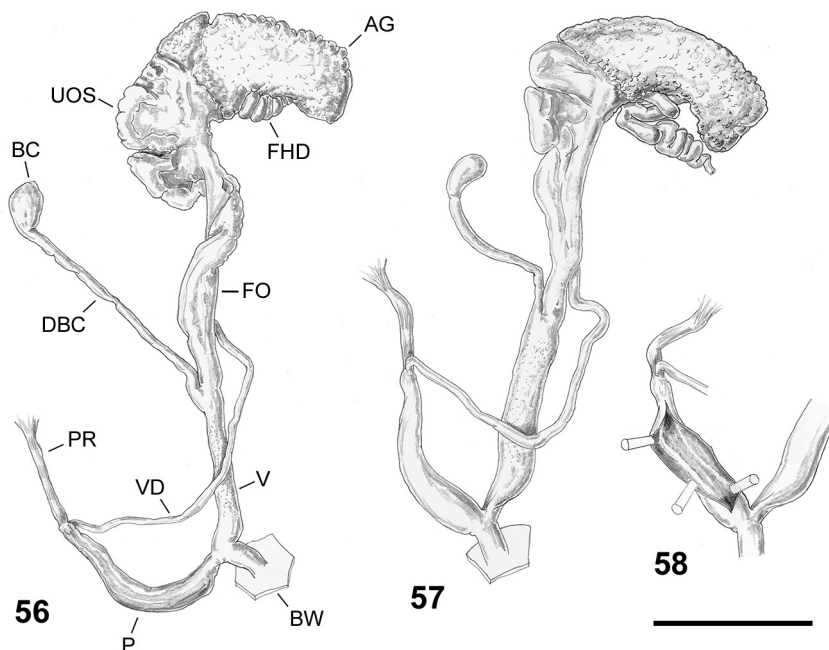

Figs 56–58. Genitalia of *Gomphroa dohrni* (Paulucci, 1882): 56–57 – general view (gonad excluded); 58 – internal structure of penis; specimens from Orroli (province of Cagliari), L. PINTÉR leg. 2.4.1978 (56) and Monte Nieddu (province of Carbonia-Iglesias), collector unknown, 23.3.1976 (57–58). Scale bar 1 mm

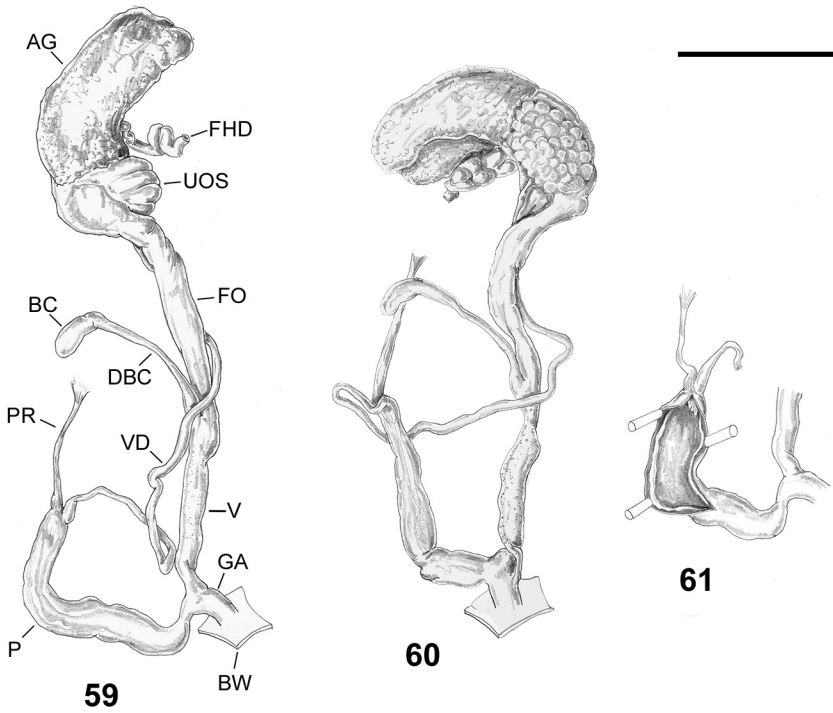

Figs 59–61. Genitalia of *Gomphroa* cf. *remyi* (Boettger, 1949): 59–60 – general view (gonad excluded); 61 – internal structure of penis; specimens from Cap Corse, Pietra Nera, L. CASTAGNOLO, F. GIUSTI & G. MANGANELLI leg. 4.12.1983. Scale bar 1 mm

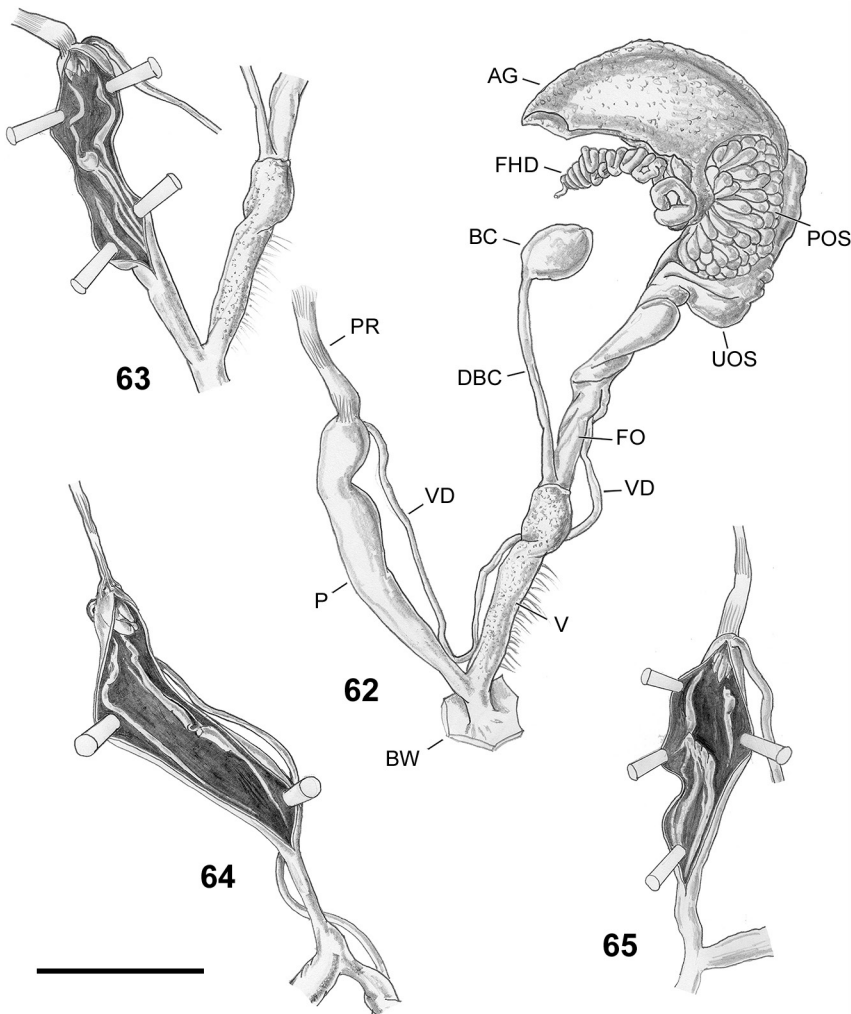

Figs 62–65. Genitalia of *Gomphroa bisacchii* (Giusti, 1970): 62 – general view (gonad excluded); 63–65 – internal structure of penis; specimens from Cala Gonone, Codula Fuili (province of Nuoro), S. CIANFANELLI & E. TALENTI leg. 19.5.2004 (62–63, 65) and Cala Gonone (province of Nuoro), F. GIUSTI leg. 2.5.1969 (64). Scale bar 1 mm

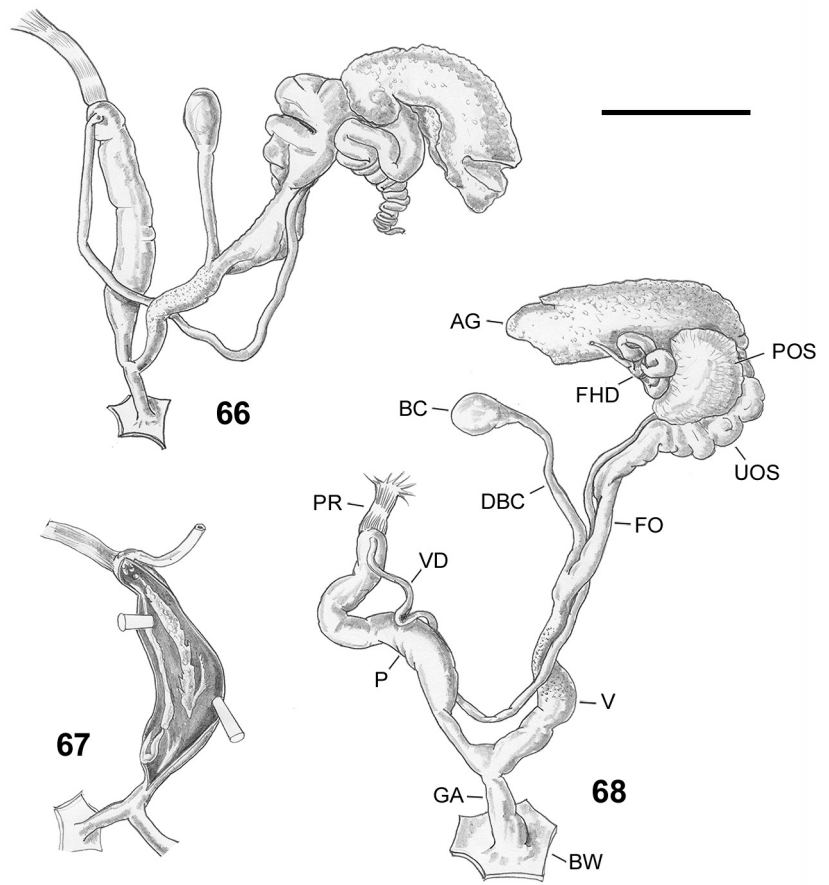

Figs 66–68. Genitalia of *Gomphroa etrusca* (Paulucci, 1886): 66, 68 – general view (gonad excluded); 67 – internal structure of penis; specimens from Monte Argentario, cemetery of Porto Santo Stefano (province of Grosseto), V. SBORDONI leg. 29.4.1978 (66–67) and Porto Santo Stefano (province of Grosseto), collector and date unknown (68). Scale bar 1 mm

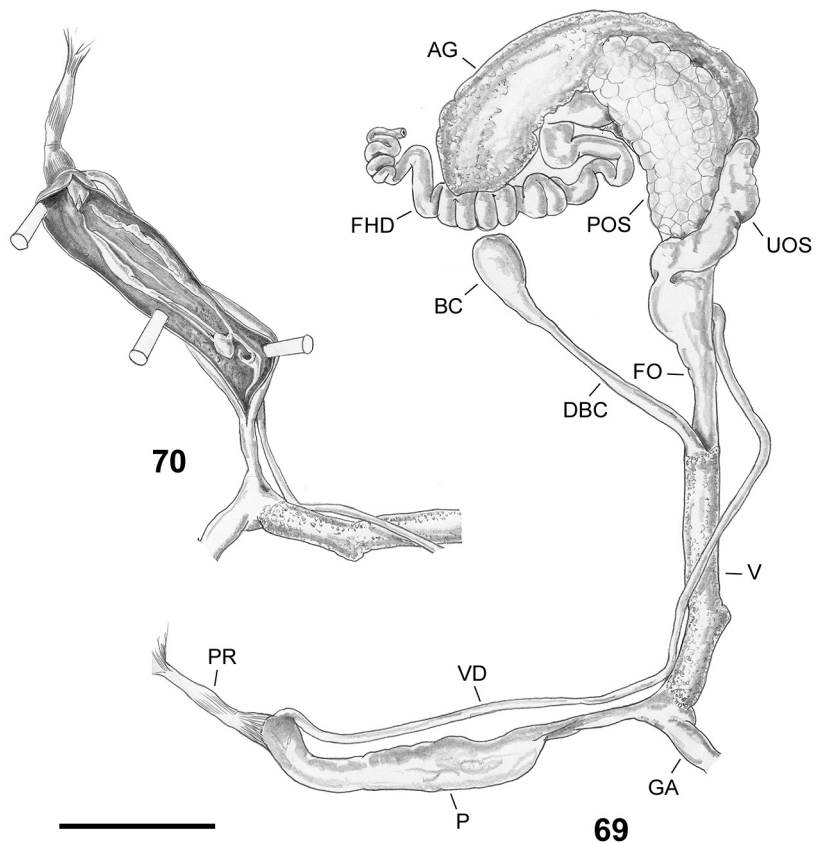

Figs 69–70. Genitalia of *Gomphroa* cf. *etrusca* (Paulucci, 1886): 69 – general view (gonad excluded); 70 – internal structure of penis; a specimen from Island of Giglio, Il Franco (province of Grosseto), A. BENOCCI, F. GIUSTI & G. MANGANELLI leg. 27.2.2013. Scale bar 1 mm

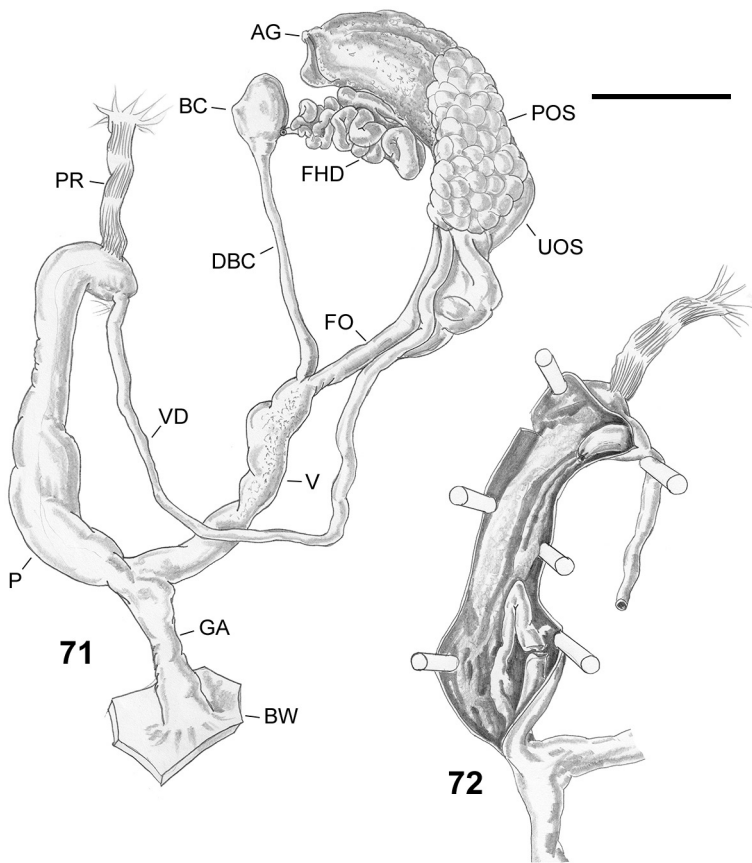

Figs 71–72. Genitalia of *Gomphroa* cf. *etrusca* (Paulucci, 1886): 71 – general view (gonad excluded); 72 – internal structure of penis; a specimen from Island of Gorgona, Torre Vecchia (province of Livorno), F. GIUSTI leg. 31.3.1974. Scale bar 1 mm

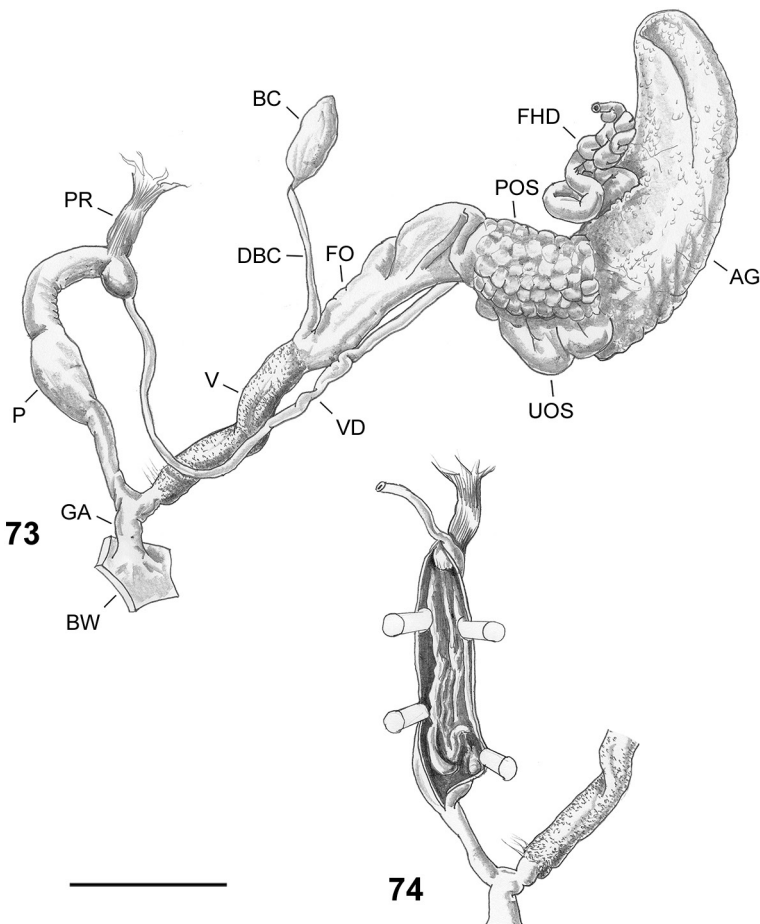

Figs 73–74. Genitalia of *Gomphroa incerta* (Bourguignat, 1858): 73 – general view (gonad excluded); 74 – internal structure of penis; a specimen from Island of Stromboli, Ginostra (province of Messina), F. GIUSTI leg. 3.11.1969. Scale bar 1 mm

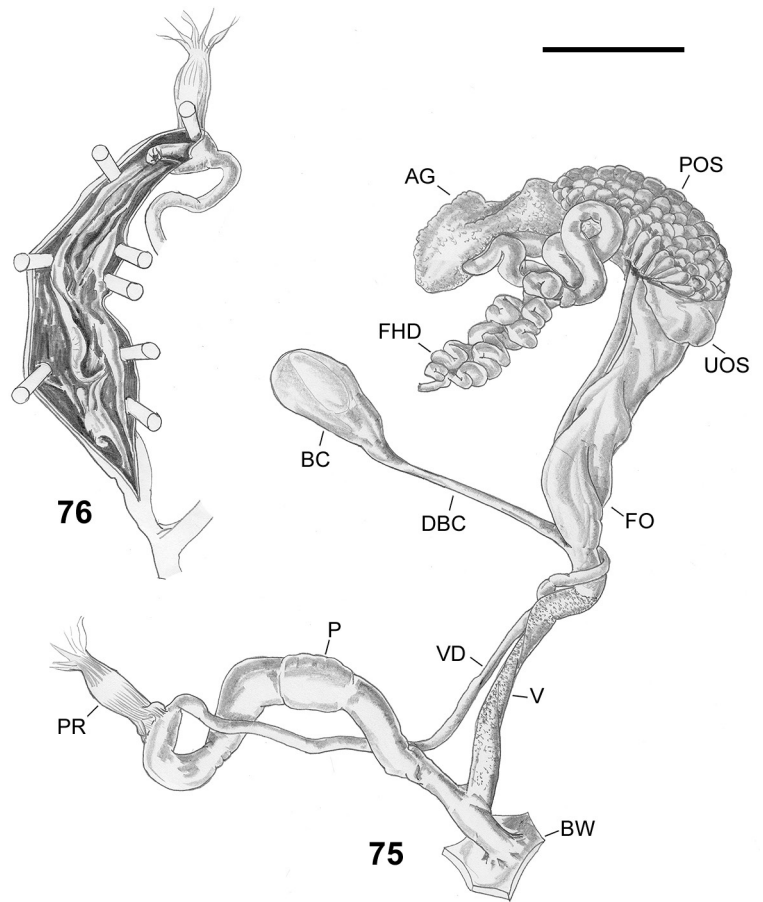

Figs 75–76. Genitalia of *Gomphroa* cf. *cylindracea* (Bourguignat, 1858): 75 – general view (gonad excluded); 76 – internal structure of penis; a specimen from Santuario di Santa Maria della Scala (province of Siracusa), D. CARUSO leg. 13.10.1977. Scale bar 1 mm

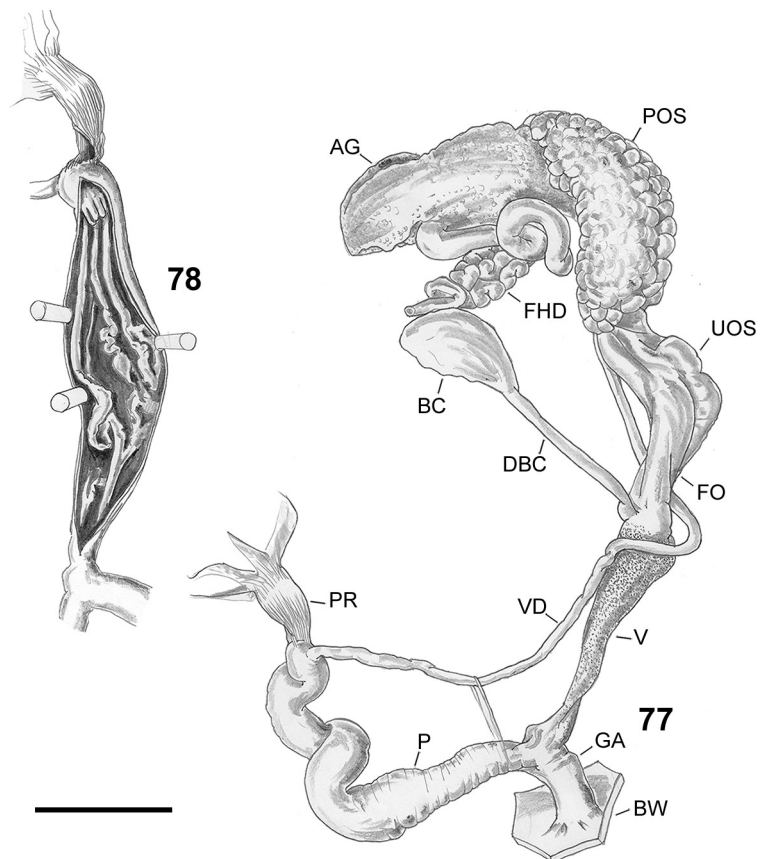

Figs 77–78. Genitalia of *Gomphroa* cf. *cylindracea* (Bourguignat, 1858): 77 – general view (gonad excluded); 78 – internal structure of penis; a specimen from Santuario di Santa Maria della Scala (province of Siracusa), D. CARUSO leg. 13.10.1977. Scale bar 1 mm

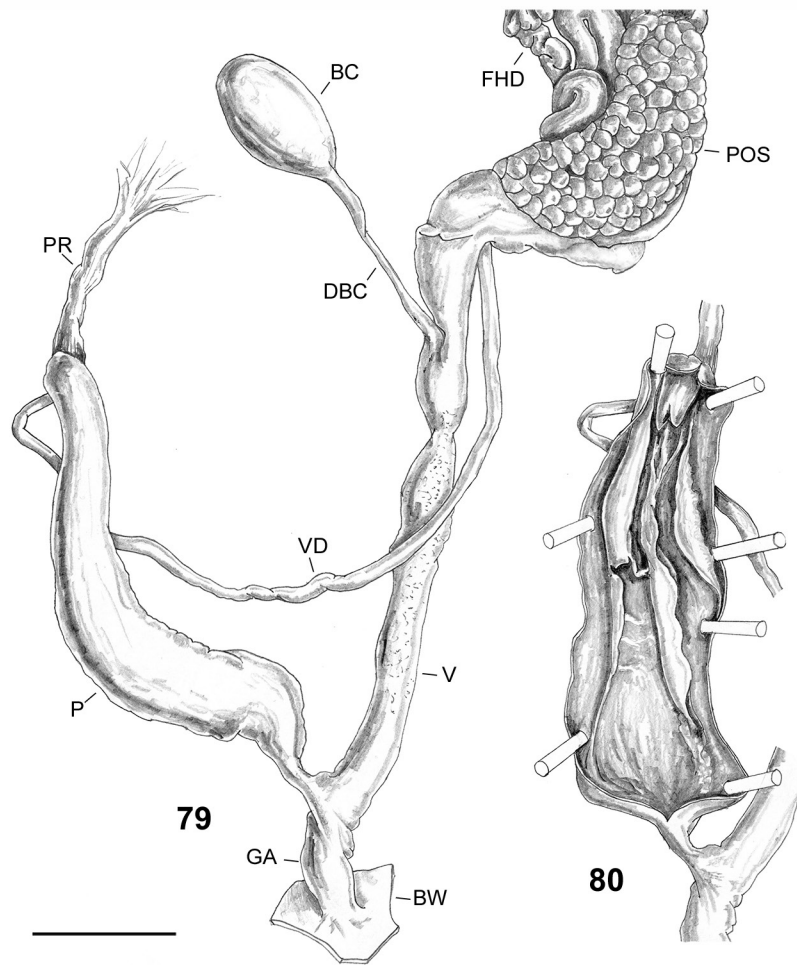

Figs 79–80. Genitalia of *Gomphroa emiliana* (Bourguignat, 1858): 79 – general view (gonad excluded); 80 – internal structure of penis; a specimen from Island of Marettimo, above the village (province of Trapani), F. GIUSTI leg. 2.4.1982. Scale bar 1 mm

Gomphroa incerta (Bourguignat, 1858) (Figs 73–74) – Italy, Sicily, Aeolian Islands: Island of Lipari, along the road to Monte Sant’Angelo (province of Messina), not georeferenceable, F. GIUSTI leg. 25.7.1972 (1 spirit specimen dissected, FGC 17277); Island of Panarea, slopes of Monte Alto (province of Messina), 33WC07, F. GIUSTI leg. 30.3.1971 (4 shells, 10 spirit specimens, 2 dissected, FGC 17273); Island of Stromboli, Ginostra, 33SWC1693, F. GIUSTI leg. 3.11.1969 (5 shells, 2 spirit specimens dissected, FGC 11005).

Gomphroa cf. *cylindracea* (Calcara, 1840) (Figs 75–78) – Sicily, Santuario di Santa Maria della Scala (province of Siracusa), 33SWA0291, D. CARUSO leg. 13.10.1977 (4 spirit specimens, 2 dissected, FGC 41618).

Gomphroa emiliana (Bourguignat, 1858) (Figs 79–80) – Italy, Sicily, Egadi Islands: Island of Marettimo, above the village (province of Trapani), 33STC4206, F. GIUSTI leg. 2.4.1982 (6 shells, 29 spirit specimens, 4 dissected, FGC 17791).

Gomphroa zirjensis (Štamol, Manganelli, Barbato et Giusti, 2018) – Croatia, Šibenik Archipelago,

Island of Žirje, Gradina (area), Gradina (pit), 33TWJ53, B. JALŽIĆ leg. 10.2004 (31 shells, CNHM 10919), B. JALŽIĆ leg. 10.2007 (7 specimens, 3 dissected, CNHM 10919).

Diagnosis

A genus of the azecids characterised by ovoid-fusiform to ovoid-cylindrical shell with callous rim on columella and parietum ending in transversely elongate angular tubercle (absent in the type species), straight outer margin with upper third thinner than elsewhere, without apertural armature (apart from barely evident subcolumellar lamella) and having a protoconch with rows of pits; radula with latero-marginal teeth; male distal genitalia with vas deferens almost uniform in diameter, penial retractor inserted basally/sub-basally, no muscular sheath on proximal penis, penial papilla consisting of bunch of short conical digit-like appendages fused at base (sometimes forming cylindrical structure with fringed tip) at opening of vas deferens inside penis (presumably absent in the type species) and longitudinal pleats with knobs and transverse crests inside penis.

Description of type species

Shell (Figs 50–53): dextral, small, imperforate, elongate cylindrical-fusiform, yellowish, glossy and transparent when fresh, with 5–6 slightly convex to flat whorls, separated by superficial sutures; aperture slightly prosocline, ovate pyriform, rounded at base, without apertural armature (apart from barely evident subcolumellar lamella); peristome not reflected, not thickened (very thin in outer upper third), with callous rim on columella and parietum interrupted and very faint (transversely elongate angular tubercle absent) and with straight outer margin; protoconch with close spiral rows of very small pits in grooves; teleoconch smooth, with very thin spiral grooves. Shell dimensions: H – 4.9–5.8 mm; D – 1.7–2.1 mm.

Body: ocular spots present.

Radula: central tooth small, tricuspid; lateral teeth large, bicuspid; latero-marginal teeth tricuspid (because ectocone split into two); marginal teeth pluricuspid (radular formula unknown).

Female distal genitalia (Fig. 54): free oviduct long and wide. Bursa copulatrix oval or bean-like with short slender duct, initially barely flared. Vagina long and rather slender, almost completely covered by faint, pale yellow to brownish muff; internal surface smooth.

Male distal genitalia (Fig. 54): vas deferens rather long, almost uniform in diameter (slightly thickened proximally, then uniformly slender), entering penis basally (its final section not enveloped by penial retractor); opening of vas deferens into penis apparently simple. Penis very short, subcylindrical, undivided, without penial sheath or penial diverticulum. Penial retractor short and thin, inserted basally close to vas deferens. Internal surface of penis not clearly resolved (due to very small size of penis), apparently with two, thin, longitudinal pleats.

Remarks

Gomphroa was introduced as a subgenus of *Zua* by WESTERLUND (1902) for a species from the eastern Pyrenees. Later it was considered a subgenus of *Azeca* (e.g. PILSBRY 1908, HESSE 1922, GERMAIN 1930, THIELE 1931) or a distinct genus (ZILCH 1959, SCHILEYKO 1998a) in the orthurethran family Cochlicopidae (ZILCH 1959, SCHILEYKO 1998a) or it was disregarded and its type species included in *Hypnophila* (GIUSTI 1976, GITTENBERGER 1983, GÓMEZ 1990a, BANK et al. 2001, WELTER-SCHULTES 2012).

Phylogeny based on morphological characters (Fig. 6) shows that *Gomphroa boissii* is characterised by at least one autapomorphy, namely very small penis (22(2)), and it has unresolved relationships with *Gomeziella girottii* and the main azecid clade including *Azeca* and all the species currently assigned to *Hypnophila*. This group (*Gomeziella girottii*, *Gomphroa*

boissii and the main azecid clade) shares at least one synapomorphy: penial longitudinal pleats (29(1)). The species currently assigned to *Hypnophila* fall into two distinct lineages: one, including the Dalmatian species except *H. zirjensis*, is characterised by cup-like initial portion of penial plica (28(1)), and is the sister group of *Azeca goodalli* based on the absence of rows of pits on the protoconch (14(0)); the other, including all the western Mediterranean species plus the Dalmatian *H. zirjensis*, is characterised by an apically fringed papilla through which the vas deferens opens into the penis (28(2)). In the western Mediterranean *Hypnophila* lineage, *H. bisacchii* is sister group to all the other species examined, due to its elongate ovoid-fusiform shell (1(0)) (elongate cylindrical-fusiform shell in the others (1(2))); in this subclade, two species – *Hypnophila dohrni* and *H. remyi* – have sister group relationships based on small penial size (22(1)).

The ML tree based on COI sequences (Fig. 7) shows that the western *Hypnophila* belong to two lineages: the first is well supported and includes species from southern France (*Hypnophila* sp. A), Sardinia (*H. bisacchii*), Tuscany and the Tuscan Archipelago (*H. etrusca*) and Pontine Archipelago (*Hypnophila* sp. B); the other is weakly supported and includes species from the Iberian Peninsula (*H. boissii* and *H. malagana*) and Sardinia and Corsica (*H. dohrni* and *H. remyi*). The ML trees of ITS2 (Fig. 8) and of concatenated COI+ITS2 (Fig. 9) sequences show all these species as members of the same well supported lineage with three subclades: one including southern French, Sardinian and Tyrrhenian species (*Hypnophila* sp. A, *Hypnophila* sp. B, *H. bisacchii* and *H. etrusca*), one including Iberian species (*H. boissii* and *H. malagana*) and one including Sardinian and Corsican species (*H. dohrni* and *H. remyi*).

It is evident that morphological and molecular phylogenetic analyses diverge regarding the relationships of *H. boissii*. Although we always emphasise that the interpretation of anatomical and molecular features should be consistent without prioritizing either of them, we think that in the light of molecular results a new interpretation of morphological data is possible. Therefore, we assign the western Mediterranean species to *Gomphroa*. After the present revision, most *Hypnophila* species come to fall in *Gomphroa*. Apart from the two species from North Africa (*G. psathyrolena* (Bourguignat, 1864) and *G. maroccana* (Mousson, 1873)), all the others are known anatomically, although some were studied for the first time here (GIUSTI 1968, 1970, 1973, 1976, GÓMEZ 1990a, present paper).

Gomphroa species usually have an evident angular tubercle, a normally developed penis and a vas deferens which is bordered by a penial papilla consisting of a bunch of short conical digit-like appendages

fused at the base (sometimes forming a cylindrical structure with fringed tip) where it opens into the penis.

Many *Gomphroa* species are very little known and are distinguished mainly on a geographical basis. Conchologically, only two species are very distinctive, the Sardinian *G. bisacchii* and the Iberian *G. malagana* (ŠTAMOL et al. 2018). Anatomical differences consist in the shape and size of the different sections of the distal genitalia. The Sardinian *G. dohrni* (Figs 55–58) and the Corsican *G. cf. remyi* (Figs 59–61) have a proportionally smaller penis; the Sicilian *G. cf. cylindracea* has a long penial papilla (Figs 76, 78; but see also the Tuscan *G. cf. etrusca* from Gorgona: Fig. 72); the Aeolian *G. incerta* has sub-basal insertion of the penial retractor (Fig. 73; but see also the Sicilian *G. cf. cylindracea* from Santuario di Santa Maria della Scala: Figs 75, 77, and the Tuscan *G. cf. etrusca* from Gorgona: Fig. 71). However, since very few specimens have been studied, it is difficult to evaluate the significance of these differences or to know whether they are due, for example, to species-specific divergence, different sexual maturation, different fixation or an artefact of pre-mortem stress. For example, this is the case of *G. etrusca*: specimens from some Tuscan islands (Giglio and Gorgona) differ slightly from those collected on Monte Argentario. Future molecular research is needed to verify the status at species level of the populations present in Italy and especially the single islands of the Tuscan Archipelago.

Genus: *Hypnocarnica* Cianfanelli et Bodon in Cianfanelli et al., 2018(b)

Figs 81–89

Type species: *Hypnocarnica micraelae* Cianfanelli et Bodon in Cianfanelli et al., 2018, by original designation

Material examined

Hypnocarnica micraelae Cianfanelli et Bodon in Cianfanelli et al., 2018 – Italy, Friuli – Venezia Giulia: southern slope of Monte Jouf (municipality of Maniago, province of Pordenone), 32TUM2015, M. BODON & S. CIANFANELLI leg. 20.8.2015 (5 shells, MZUF GC/47777; 3 shells, MZUF GC/47778), M. CALCAGNO & S. CIANFANELLI leg. 20.4.2016 (91 shells, 1 specimen dissected, MZUF GC/50063); south-western slope of Monte Jouf (municipality of Maniago, province of Pordenone), 32TUM1916, E. BODON, M. BODON & S. CIANFANELLI leg. 3.4.2015 (1 shell, MZUF GC/46982).

Diagnosis

A genus of the orthurethrans characterised by very elongate, cylindrical to conical shell with sinuous (more or less inverted S-like), thin outer margin, without apertural armature (apart from barely evident subcolumellar lamella) and protoconch with rows of pits; radula with latero-marginal teeth; male distal genitalia with vas deferens almost uniform in diameter, penial retractor inserted basally, no muscular sheath on proximal penis, true penial papilla at opening of vas deferens into penis and large tongue-like structure, possibly a sort of sarcobelum or stimulatory organ inside final part of proximal penis.

Description of type species

Shell (Figs 81–86): dextral, small, imperforate, elongate to very elongate, cylindrical or cylindro-conical, colourless, glossy and transparent when fresh, with $5\frac{1}{2}$ – $5\frac{3}{4}$ slightly convex to flat whorls, separated by superficial sutures; aperture slightly prosocline, oblique pyriform, rounded at base, with simplified apertural armature (consisting of barely evident subcolumellar lamella); peristome not reflected, thin along entire outer margin and more or less continuous, with sinuous (more or less inverted S-like) outer margin; protoconch smooth; teleoconch with very thin spiral grooves particularly evident on last whorl near aperture. Shell dimensions: H – 4.4–8.3 mm; D – 1.3–2.3 mm.

Body: eye spots absent.

Radula: central tooth small, tricuspid; lateral teeth large, bicuspid; latero-marginal tooth tricuspid (ectocone split into two); marginal teeth pluricuspid (up to 9 cusps) (radular formula: M ca. 10/6-14 + LM 1/3-5 + L 4/2 + C 1/3 + L 4/2 + LM 1/3-5 + M ca. 10/6-14).

Female distal genitalia (Figs 87–88): free oviduct short. Bursa copulatrix oval with very long wide duct, initially not flared and rather slender at its end. Vagina short and wide, covered by thin brownish muff; internal surface smooth.

Male distal genitalia (Figs 87–89): vas deferens rather long, almost uniform in diameter, entering penis basally; opening of vas deferens into penis through true penial papilla. Penis long, divided into proximal and distal parts of different diameter; proximal part bean-like, without penial sheath or penial diverticulum, divided by slight constriction into small initial part internally with penial papilla and large final part internally with large tongue-like structure, possibly a sort of sarcobelum or stimulatory organ; distal part initially slender, widening distally. Penial retractor rather short and robust, inserted basally, close to vas deferens. Internal surface of penis smooth.



Figs 81–86. Shells of *Hypnocarnica micaelae* Cianfanelli et Bodon in Cianfanelli et al., 2018(b): 81 – a specimen from the south-western slope of Monte Jouf (province of Pordenone), E. BODON, M. BODON & S. CIANFANELLI leg. 3.4.2015; 82–85 – specimens from the southern slope of Monte Jouf (province of Pordenone), M. BODON & S. CIANFANELLI leg. 20.8.2015 (82 – MZUF 47778), M. BODON & S. CIANFANELLI leg. 20.8.2015 (83, 85 – MZUF 47777) and M. CALCAGNO & S. CIANFANELLI leg. 20.4.2016 (84, 86 – MZUF 50063). Scale bar 2 mm

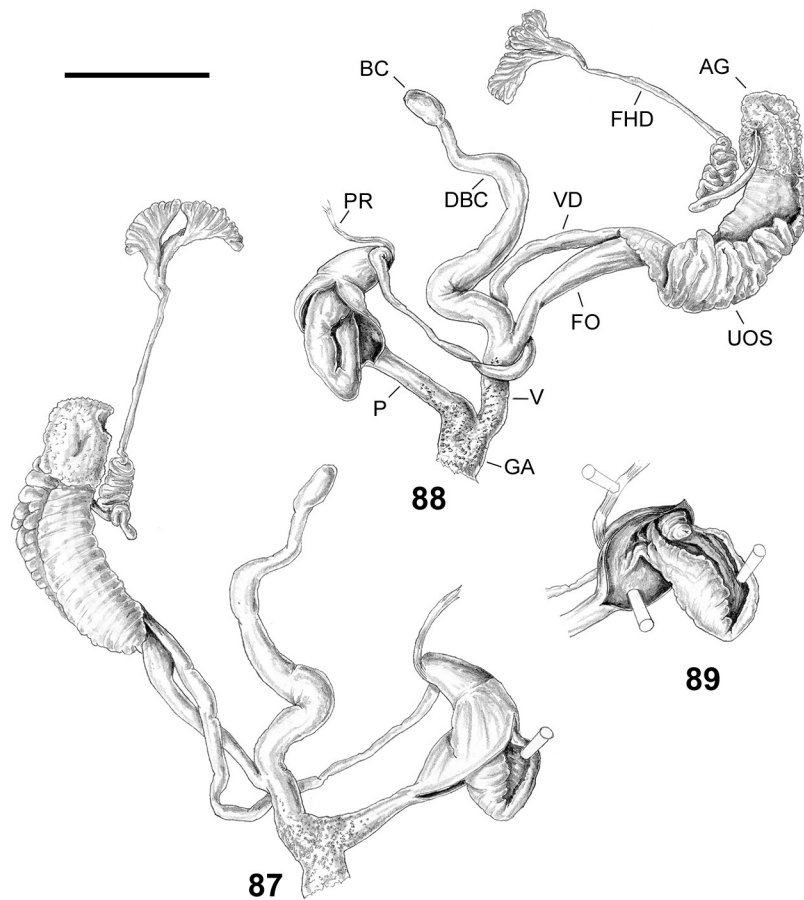

Figs 87–89. Genitalia of *Hypnocarnica micaelae* Cianfanelli et Bodon in Cianfanelli et al., 2018(b): 87–88 – general view (gonad excluded); 89 – internal structure of proximal penis with penial papilla and tongue-like structure; a specimen from the southern slope of Monte Jouf (province of Pordenone), M. CALCAGNO & S. CIANFANELLI leg. 20.4.2016. Scale bar 1 mm

Remarks

Hypnocarnica was introduced for a new species from the Carnic Prealps, north-eastern Italy, assigned to the azecids on the basis of morphological and molecular characters. Its shell is very similar in shape, size and variation to that of species of *Cecilioides* with very slender shells, like those of *C. acicula*, and less slender shells like those of *C. petitianus/tumulorum/janii*. It is surprising that no name established for *Cecilioides* was available for this species. Although its shell is similar to that of *Cecilioides*, the orthurethran kidney excludes any relationship with the sigmurethran ferussaciids.

Regarding the internal structure of the penis, CIANFANELLI et al. (2018b) failed to detect the true penial papilla at the opening of vas deferens inside the proximal penis and interpreted the more distal tongue-like structure as a penial papilla.

Phylogeny based on morphological characters (Fig. 6) shows that *H. micaelae* is the sister group of all the other azecids and is characterised by at least three autapomorphies, namely very elongate, cylindrical-conical or cylindrical-fusiform shell (1(4)), eye spots absent (15(1)) and tongue-like structure inside proximal penis (31(1)).

The Bayesian Inference tree based on concatenated sequences by CIANFANELLI et al. (2018b: fig. 7) shows that *H. micaelae* has sister group relationships with all the other azecids. The ML tree based on COI sequences (Fig. 7) weakly confirms this hypothesis, whereas in the ML trees of ITS2 (Fig. 8) and concatenated COI+ITS2 (Fig. 9) sequences *H. micaelae* forms a cluster together with *Cryptazeca monodonta*. More research is necessary to elucidate its relationships with the other azecids.

Genus: *Hypnophila* Bourguignat, 1858

Figs 90–95

Type species: *Bulimus pupaeformis* Cantraine, 1835, by subsequent designation (PILSBRY 1908)

Material examined

Hypnophila pupaeformis (Cantraine, 1835) – Croatia: Dubrovnik, collector unknown leg. 9.1969 (3 shells, FGC 19589); Island of Vis, Komiža, F. GIUSTI leg. 23.7.1968 (5 shells, FGC 19009); Sipun pećina, Cavtat, E. GITTENBERGER leg. 2.5.1974 (1 spirit specimen dissected, FGC 19010); Sipun pećina, Cavtat, R.O. IZVEDELY leg. 7.5.2012 (3 spirit specimens, 1 dissected, FGC 41613), B. JALŽIĆ 15.5.2018 (8 spirit specimens, 2 dissected, FGC 48643).

Hypnophila zacynthia (Roth, 1855) – Greece, Iónia Nisiá: Island of Kefalloniá, Karavomilos, E. GITTENBERGER leg. 6.5.1979 (2 shells, FGC

19505); Island of Kefalloniá, Póros, W. RÄHLE leg. 28.9.1980 (1 spirit specimen dissected, FGC 17280); Island of Itháki, 0.8 km N of Itháki village, collector and date unknown (2 shells, FGC 41742).

Diagnosis

A genus of the azecids characterised by ovoid-fusiform to ovoid-cylindrical shell with callous rim on columella and parietum ending in transversely elongate angular tubercle, almost straight outer margin with upper third thinner than elsewhere, without apertural armature (apart from barely evident subcolumellar lamella) and protoconch without rows of pits; radula with latero-marginal teeth; male distal genitalia with vas deferens almost uniform in diameter, penial retractor inserted basally, no muscular sheath on proximal penis and two longitudinal pleats with thickened parts that fuse proximally, giving rise to small pointed cup-like crest bordering opening of vas deferens inside penis.

Description of type species

Shell (Figs 90–92): dextral, small, imperforate, elongate ovoid-fusiform, pale-brownish or yellowish, glossy and transparent when fresh, with 6½–7, slightly convex to flat whorls, separated by superficial sutures; aperture slightly prosocline, ovate pyriform, rounded at base, without apertural armature (apart from barely evident subcolumellar lamella); peristome not reflected, not thickened (thin in its outer upper third), with callous rim on columella and parietum sometimes continuous, faint and ending in transversely elongate angular tubercle separated by deep notch from upper angle of aperture and with straight outer margin; protoconch with slightly raised, interrupted radial crests; teleoconch smooth, with very thin spiral grooves. Shell dimensions: H – 6.5–7.6 mm; D – 2.6–3.3 mm according to GITTENBERGER (1993).

Body: eye spots present.

Radula: central tooth small, tricuspid; lateral teeth large, bicuspid; latero-marginal teeth tricuspid (because ectocone split into two); marginal teeth pluricuspid (up to 9 cusps) (radular formula: M 13/3-9 + LM 2/3 + L 8/2 + C 1/3 + L 8/2 + LM 2/3 + M 13/3-9).

Female distal genitalia (Fig. 93): free oviduct long and wide. Bursa copulatrix oval or pyriform with long and rather wide duct, initially barely flared. Vagina short and wide, proximally covered by thick, brownish muff; internal surface smooth.

Male distal genitalia (Figs 93–95): vas deferens rather long, almost uniform in diameter (slightly thickened proximally, then uniformly slender), entering penis basally (its final section more or less enveloped by penial retractor); opening of vas deferens



Figs 90–92. Shells of *Hypnophila pupaeformis* (Cantraine, 1835): specimens from Island of Vis, Komiža, F. GIUSTI leg. 23.7.1968. Scale bar 2 mm

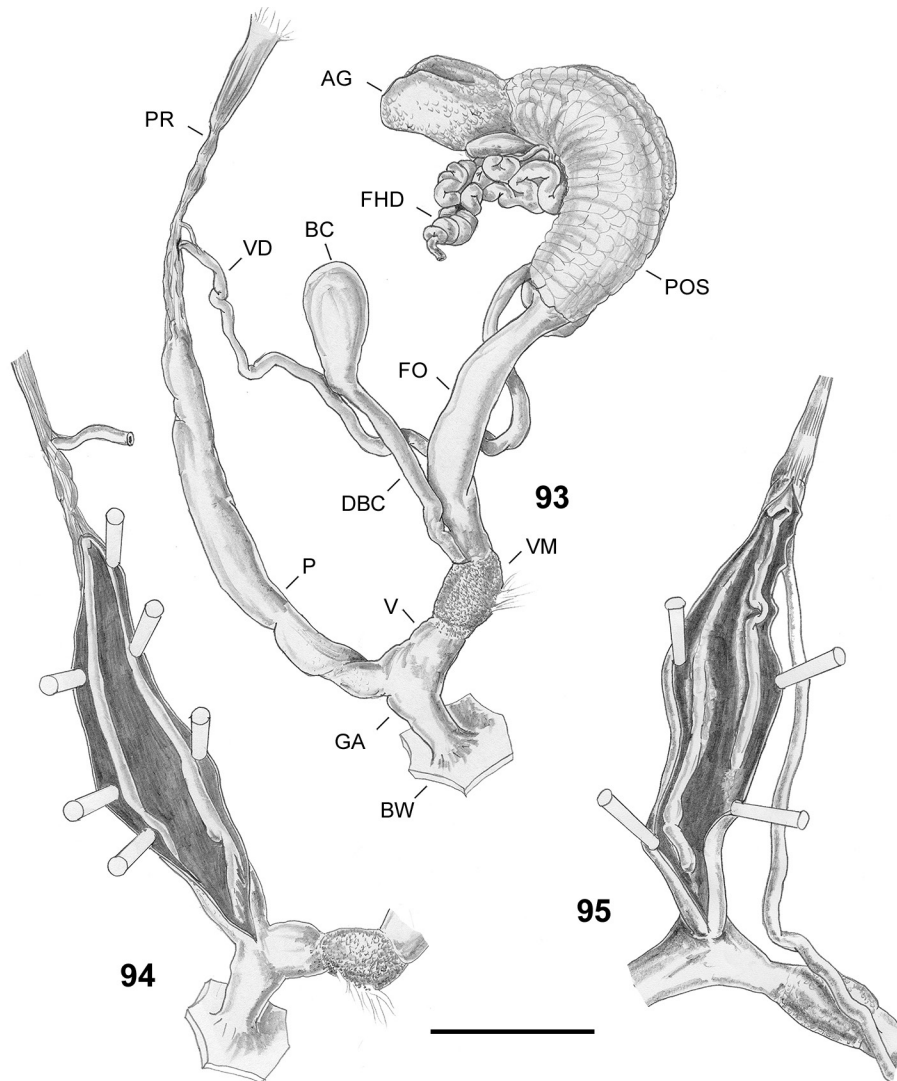

Figs 93–95. Genitalia of *Hypnophila pupaeformis* (Cantraine, 1835): 93 – general view (gonad excluded); 94–95 – internal structure of penis; specimens from Sipun pećina at Cavtat, E. GITTENBERGER leg. 2.5.1974 (93–94) and R.O. IZVEDELY leg. 7.5.2012 (95). Scale bar 1 mm



into penis bordered by initial section of shorter penial pleat. Penis long, uniformly cylindrical, undivided, without penial sheath or penial diverticulum. Penial retractor rather long and robust, inserted basally, enveloping final section of vas deferens. Internal surface of penis with two longitudinal pleats that arise proximally; shorter pleat runs for 2/3 of penis length and at its beginning gives rise to small pointed cup-like crest bordering opening of vas deferens into penis; longer pleat, initially very slender then progressively larger, runs for entire length of penis and ends close to genital atrium, fringing or giving rise to thickened parts.

R e m a r k s

Hypnophila was established for a “series” of *Azeca* by BOURGUIGNAT (1858) with six species originally included. It was subsequently regarded as a subgenus of *Azeca* (PILSBRY 1908, HESSE 1922, GERMAIN 1930, THIELE 1931) or a distinct genus (ZILCH 1959, BANK et al. 2001) in the orthurethran families Cochlicopidae (ZILCH 1959) or Azecidae (BANK et al. 2001).

Phylogeny based on morphological characters (Fig. 6) shows that *Hypnophila* species belong to a monophyletic group supported by two synapomorphies: the elongate ovoid-cylindrical shell (1(2)) and the cup-like initial portion of one of the two penial pliae bordering the vas deferens opening into the penis (28(1)). This clade constitutes the sister group of *Azeca* based on loss of the rows of pits on protoconch (14(0)); in turn, *Azeca* plus *Hypnophila* are the sister group of the lineage including *Gomphroa* species except *G. boissii* based on the transversely elongate tubercle on the outermost parietum (3(1)). Unfortunately no

molecular data are available on *Hypnophila* and this prevents any discussion of its relationships revealed by phylogeny based on morphological characters.

Currently *Hypnophila* includes 15 species (GIUSTI & MANGANELLI 1984, WELTER-SCHULTES 2012, ŠTAMOL et al. 2018) but after the present revision, only four remain, all from western Balkan Peninsula and from western Greece, islands included: the type species (*H. pupaeformis*) plus *H. polita* (Porro, 1838), *H. cyclothyra* (Boettger, 1885) and *H. zacynthia* (Roth, 1855) (GITTEBERGER 1993). These three species differ from *H. pupaeformis* and from each other in very few shell characters and in some cases show overlapping distributions (GITTEBERGER 1993: fig. 5).

ACKNOWLEDGEMENTS

HELEN AMPT (Siena, Italy) revised the English. GIOVANNI CAPPELLI (Siena, Italy) photographed the shells. MARCO BODON (Genoa, Italy), SIMONE CIANFANELLI (Florence, Italy), DAVID T. HOLYOAK & GERALDINE A. HOLYOAK (Cabeçudo, Portugal), ALESSANDRO MARGELLI (Pisa, Italy), and ADRIAN NORRIS (Leeds, UK) provided information or loaned material from their private collections. SIMONE CIANFANELLI (Museo di Storia Naturale, Sezione Zoologica de “La Specola”, Università di Firenze, Italy), EDMUND GITTEBERGER (Rijksmuseum van Natuurlijke Historie; Leiden, The Netherlands), BENJAMIN GÓMEZ (Universidad País Vasco; Vitoria-Gasteiz, Spain), VESNA ŠTAMOL (Croatian Natural History Museum; Zagreb, Croatia) and FRANCESC URIBE (Museu de Ciències Naturals; Barcelona, Spain) provided information or loaned material from the collections of their respective museums or institutions.

REFERENCES

- ARMBRUSTER G. F. J., BOEHME M., BERNHARD D., SCHLEGEL M. 2005. The H3/H4 histone gene cluster of land snails (Gastropoda: Stylommatophora): TS/TV ratio, GC3 drive and signals in stylommatophoran phylogeny. *Journal of Molluscan Studies* 71: 339–348. <https://doi.org/10.1093/mollus/eyi038>
- BAKER H. B. 1935. Review of the anatomy of Pupillidae and related groups. In: TRYON G. W., PILSBRY H. A. *Manual of Conchology, Second Series: Pulmonata*, Academy of Natural Sciences, Philadelphia, 28 (4): 191–226.
- BANK R. A., BOUCHET P., FALKNER G., GITTEBERGER E., HAUSDORF B., VON PROSCHWITZ T., RIPKEN TH. E. J. 2001. Supraspecific classification of European non marine Mollusca (CLECOM Sections I + II). *Heldia* 4(1/2): 77–128.
- BANK R. A., NEUBERT E. 2017. Checklist of the land and freshwater Gastropoda of Europe. Last update: July 16th, 2017. Available on-line at <http://www.marine-species.org/aphia.php?p=sourcedetails&id=279050> (accessed 20 August 2019)
- BARKER G. M. 1999. Naturalised terrestrial Stylommatophora (Mollusca: Gastropoda). *Fauna of New Zealand* 38: 1–254.
- BENOIT L. 1862. Illustrazione sistematica critica iconografica de’ testacei estramarini della Sicilia Ulteriore e delle isole circostanti. *Quaderno* 4: 181–248. Nobile, Napoli.
- BOETTGER C. R. 1949. Eine neue Landschnecke von der Insel Corsica. *Archiv für Molluskenkunde* 78: 167–168.
- BOETTGER O. 1885. Zur Fauna von Elis und Achaia. *Nachrichtsblatt der Deutschen Malakozoologischen Gesellschaft* 17: 117–123.
- BOUCHET P., ROCROI J.-P. (FRÝDA J., HAUSDORF B., PONDER W., VALDÉS Á., WARÉN A.) 2005. Classification and nomenclator of gastropod families. *Malacologia* 47: 1–397.
- BOUCHET P., ROCROI J.-P., HAUSDORF B., KAIM A., KANO Y., NÜTZEL A., PARKHAEV P., SCHRÖDL M., STRONG E. 2017.



- Revised classification, nomenclator and typification of gastropod and monoplacophoran families. *Malacologia* 61: 1–526. <https://doi.org/10.4002/040.061.0201>
- BOURGUIGNAT J. R. 1856. Aménités malacologiques. *Revue et Magasin de Zoologie pure et appliquée* (2) 8: 424–435.
- BOURGUIGNAT J. R. 1858–59. Aménités malacologiques; § LXVIII. Notice monographique sur le genre *Azeca*. *Revue et Magasin de Zoologie pure et appliquée* (2) 10: 527–545 (1858); 11: 16–21 (1859).
- BOURGUIGNAT J. R. 1864. *Malacologie de l'Algérie ou histoire naturelle des animaux mollusques terrestres et fluviatiles recueillis jusqu'à ce jour dans nos possessions du nord de l'Afrique*. Vol. 2. Challamel Ainé, Paris, Bastide, Alger. <https://doi.org/10.5962/bhl.title.50401>
- BOYCOTT A. E. 1919. The genitalia of *Azeca tridens* and *Cochlicopa lubrica*. *Journal of Conchology* 16: 53–54.
- CALCARA P. 1840. *Monografie dei generi Clausilia e Bulimo, coll'aggiunta di alcune nuove specie di conchiglie siciliane esistenti nella collezione della Sig. Teresa Gargotta in Salinas*. *Giornale di Scienze, Lettere ed Arti per la Sicilia* 76: 1–54.
- CANTRAINE F. 1835. Les diagnoses ou descriptions succinctes de quelques espèces nouvelles de mollusques. *Bulletins de l'Académie Royale des Sciences et Belles-Lettres de Bruxelles* (1) 2 (11): 380–401.
- CHARPENTIER J. DE 1837. *Catalogue des mollusques terrestres et fluviatiles de la Suisse*. Formant la seconde partie de la faune Helvétique. *Neue Denkschriften der Allgemeinen Schweizerischen Gesellschaft für die Gesamten Naturwissenschaften – Nouveaux Mémoires de la Société Helvétique des Sciences Naturelles* 1(2): 1–28. <https://doi.org/10.5962/bhl.title.10700>
- CIANFANELLI S., BODON M., GIUSTI F., MANGANELLI G. 2018a. *Gomeziella*: a new genus for a living fossil (Gastropoda: Pulmonata: Azecidae). *Basteria* 82: 19–27.
- CIANFANELLI S., BODON M., SOMOZA E., GÓMEZ-MOLINER B. J. 2018b. A new azecid from the Carnic Pre-Alps: *Hypnocarnica micaelae* gen. et sp. nov. (Gastropoda: Eupulmonata: Azecidae). *Archiv für Molluskenkunde* 147: 87–100. <https://doi.org/10.1127/arch.moll/147/087-100>
- DE BETTA E., MARTINATI P. 1855. *Catalogo dei molluschi terrestri e fluviatili viventi nelle provincie Venete*. Antonelli, Verona. <https://doi.org/10.5962/bhl.title.13113>
- DEWAARD J. R. 2017. Canadian National Parks Data Release. Available on-line at <https://www.ncbi.nlm.nih.gov/nuccore/MF545160> (accessed 25 April 2018).
- DINAPOLI A., ZINSSMEISTER C., KLUSSMANN-KOLB A. 2011. New insight into the phylogeny of Pyramidellidae (Gastropoda). *Journal of Molluscan Studies* 77: 1–7. <https://doi.org/10.1093/mollus/eyq027>
- DUPUY D. 1851. *Histoire naturelle des mollusques terrestres et d'eau douce qui vivent en France*. 4e fascicule: [3 pp.], 331–458. Masson, Paris.
- ESU D. 1978. La malacofauna continentale pliopleistocénica della formazione fluvio-lacustre di Nuraghe Su Casteddu (Sardegna orientale) e sue implicazioni paleogeografiche. *Geologica Romana* 17: 1–33.
- FALKNER G., RIPKEN T., FALKNER M. 2002. Mollusques continentaux de France: liste de référence annotée et bibliographie. *Patrimoines Naturels* 52: 1–350.
- FARRIS J. S. 1969. A successive approximations approach to character weighting. *Systematic Biology* 18: 374–385. <https://doi.org/10.2307/2412182>
- FELSENSTEIN J. 1985. Confidence limits on phylogenies: an approach using the bootstrap. *Evolution* 39: 783–791. <https://doi.org/10.1111/j.1558-5646.1985.tb00420.x>
- FÉRUSSAC A. E. J. P. J. F. D'AUDEBARD DE 1814. *Mémoires géologiques sur les terrains formés sous l'eau douce par les débris fossiles des mollusques vivant sur la terre ou dans l'eau non salée*. Poulet, Paris.
- FÉRUSSAC A. E. J. P. J. F. D'AUDEBARD DE 1821. *Tableaux systématiques des animaux mollusques classés en familles naturelles, dans lesquels on a établi la concordance de tous les systèmes; suivis d'un prodrome général pour tous les mollusques terrestres ou fluviatiles, vivants ou fossiles*. *Prodrome Limaçons* (part 3.): 57–76 [Quarto ed.] vs. 49–72 [Folio ed.]. Bertrand-Sowerby, Paris, Londres.
- FLEMING J. 1828. *A history of British animals, exhibiting the descriptive characters and systematic arrangement of the genera and species of quadrupeds, birds, reptiles, fishes, Mollusca, and Radiata of the United Kingdom; including the indigenous, extirpated, and extinct kinds, together with periodical and occasional visitants*. Bell & Bradfute, Edinburgh. <https://doi.org/10.5962/bhl.title.12859>
- FOLIN A. G. L. DE 1891. Sur un mollusque nouveau. *Cryptazeca monodonta* nov. gen. nov. spec. *Le Naturaliste* (2) 13 (113): 264–267.
- FOLIN A. G. L. DE, BÉRILLON F. 1877a. Contribution à la faune malacologique de la région extrême S.-O. de la France. *Bulletin de la Société de Borda à Dax* 2: 199–210.
- FOLIN A. G. L. DE, BÉRILLON F. 1877b. Contributions à la faune malacologique de la région extrême S.-O. de la France. Fascicule III. *Bulletin de la Société de Borda à Dax* 2: 439–454.
- GERMAIN L. 1930. Mollusques terrestres et fluviatiles (première partie). *Faune de France* 21: 1–477, I–VIII [= 1–8], Pl. I–XIII [= 1–13]. Lechevalier, Paris.
- GITTENBERGER E. 1983. On Iberian Cochlicopidae and the genus *Cryptazeca* (Gastropoda, Pulmonata). *Zoologische Mededelingen* 57: 301–320.
- GITTENBERGER E. 1993. The southeast European *Hypnophila* species (Mollusca: Gastropoda Pulmonata: Cochlicopidae). *Zoologische Mededelingen* 67: 517–524.
- GIUSTI F. 1968. *Notulae Malacologicae – V*. Le isole di Gorgona, Capraia e Giglio. *Atti della Società Toscana di Scienze Naturali Residente in Pisa Memorie Serie B* 75: 265–324.
- GIUSTI F. 1970. *Notulae Malacologicae. XI*. Alcune nuove specie di Molluschi terrestri dell'Isola di Sardegna. *Atti della Società Toscana di Scienze Naturali Residente in Pisa Memorie Serie B* 77: 67–87.

- GIUSTI F. 1973. Notulae Malacologicae XVIII. I Molluschi terrestri e salmastri delle Isole Eolie. Lavori della Società Italiana di Biogeografia (Nuova Serie) 3: 113–306. <https://doi.org/10.21426/B63110502>
- GIUSTI F. 1976. Notulae Malacologicae XXIII. I Molluschi terrestri, salmastri e di acqua dolce dell'Elba, Giannutri e scogli minori dell'Arcipelago Toscano. Conclusioni generali sul popolamento malacologico dell'Arcipelago Toscano e descrizione di una nuova specie. (Studi sulla Riserva naturale dell'Isola di Montecristo, IV). Lavori della Società Italiana di Biogeografia (Nuova Serie) 5: 99–355. <https://doi.org/10.21426/B65110074>
- GIUSTI F., MANGANELLI G. 1984. Relationships between geological land evolution and present distribution of terrestrial gastropods in the western Mediterranean area. In: SOLEM A., VAN BRUGGEN A. C. (eds). World-wide snails. Biogeographical studies on non-marine Mollusca. Brill, Leiden, pp. 70–92.
- GÓMEZ B. J. 1988. Estudio sistemático y biogeográfico de los moluscos terrestres del Suborden Orthurethra (Gastropoda: Pulmonata: Stylommatophora) del País Vasco y regiones adyacentes, y catálogo de las especies ibéricas. Doctoral thesis (unpublished), Universidad del País.
- GÓMEZ B. J. 1990a. Estudio anatómico y conchiológico de las especies ibéricas de *Hypnophila* (Pulmonata, Stylommatophora). *Iberus* 9: 387–392.
- GÓMEZ B. J. 1990b. Descripción de una nueva especie troglobia de *Cryptazeca* (Mollusca, Gastropoda). *Bulletin du Muséum National d'Histoire Naturelle* IV, Série 12: 365–374.
- GÓMEZ B. J. 1990c. Description of a new species of the genus *Cryptazeca* from the north of the Iberian Peninsula (Gastropoda: Pulmonata: Cochlicopidae). *Archiv für Molluskenkunde* 119: 219–225.
- GÓMEZ B. J. 1991. Morphological and histological study of the genital ducts of *Cryptazeca monodonta* (Pulmonata, Orthurethra), with special emphasis on the auxiliary copulatory organ. *Zoomorphology* 111: 95–102. <https://doi.org/10.1007/BF01632875>
- GÓMEZ B. J., ANGULO E. 1987. On the systematic position of the genus *Cryptazeca* (Gastropoda: Pulmonata). *Archiv für Molluskenkunde* 118: 57–62.
- GÓMEZ B. J., ANGULO E. 1990. Anatomical and histological studies on the spermooviduct of *Azeca goodalli* (Pulmonata: Orthurethra). *Journal of Molluscan Studies* 56: 109–112. <https://doi.org/10.1093/molus/56.1.109>
- GOULD A. A. 1848. [Descriptions of the following species of *Partula*, *Pupa*, and *Balea*, collected by the Exploring Expedition.] *Proceedings of the Boston Society of Natural History* 2: 196–198.
- HALL T. A. 1999. BioEdit: a user friendly biological sequence alignment editor and analysis program for Windows 95/98/NT. *Nucleic Acids Symposium Series* 41: 95–98. <http://brownlab.mbio.ncsu.edu/JWB/papers/1999Hall1.pdf>
- HAUSDORF B. 1996. Die Orculidae Asiens (Gastropoda Stylommatophora). *Archiv für Molluskenkunde* 125: 1–86. <https://doi.org/10.1127/arch.moll/125/1996/1>
- HESSE P. 1922. Die Anatomie der Deutschen Ferussaciidae, mit Bemerkungen über die Systematik der Familie. *Archiv für Molluskenkunde* 54: 49–74.
- HOLYOAK D. T., HOLYOAK G. A. 2012. A review of species-limits in some *Cryptazeca* (Gastropoda: Azecidae). *Iberus* 30: 91–102.
- ICZN 1953. Opinion 335. Addition to the 'Official List of Generic Names in Zoology' of the names of thirty-four non-marine genera of the phylum Mollusca. Opinions and Declarations rendered by the International Commission on Zoological Nomenclature 10: 45–76.
- ICZN 1999. International code on zoological nomenclature. Fourth edition adopted by the International Union of Biological Sciences. The International Trust for Zoological Nomenclature, London.
- KERNEY M. P., CAMERON R. A. D., JUNGBLUTH J. H. 1983. Die Landschnecken Nord- und Mitteleuropas. Paul Parey, Hamburg und Berlin.
- KIMURA M. 1980. A simple method for estimating evolutionary rate of base substitutions through comparative studies of nucleotide sequences. *Journal of Molecular Evolution* 16: 111–120. <https://doi.org/10.1007/BF01731581>
- KOBELT W. 1894. Iconographie der Land- & Süßwasser-Mollusken mit vorzüglicher Berücksichtigung der europäischen noch nicht abgebildeten Arten von E. A. Rossmässler. Neue Folge. Siebenter Band, Heft 1–2 (10 Aug 1894): pp. 1–40. Kreidel, Wiesbaden.
- KORES P. J., WESTON P. H., MOLVRAJ M., CHASE W. 2000. Phylogenetic relationship within the Diurideae (Orchidaceae): inferences from plastid matK DNA sequences. In: WILSON K. L., MORRISON D. A. (eds). *Monocots: systematics and evolution*. CSIRO, Collingwood (Australia), pp. 449–456.
- KUMAR S., STECHER G., TAMURA K. 2016. MEGA7: Molecular Evolutionary Genetics Analysis version 7.0 for bigger datasets. *Molecular Biology and Evolution* 33: 1870–1874. <https://doi.org/10.1093/molbev/msw054>
- MADEIRA M. J., ELEJALDE M. A., CHUECA L. J., GÓMEZ-MOLINER B. J. 2010. Phylogenetic position of the genus *Cryptazeca* and the family Azecidae within the system of the Stylommatophora. *Malacologia* 52: 163–168. <https://doi.org/10.4002/040.052.0110>
- MANGANELLI G., BODON M., FAVILLI L., GIUSTI F. 1995. Gastropoda Pulmonata. In: MINELLI A., RUFFO S., LA POSTA S. (eds): *Checklist delle specie della fauna d'Italia*, 16. Edizioni Calderini, Bologna, pp. 1–60.
- MOUSSON A. 1873. Diagnosen neuer Mollusken aus West-Marocco von Dr. von Fritsch und Dr. Rein gesammelt. *Malakozoologische Blätter* 21: 149–157.
- MÜLLER O. F. 1774. Vermium terrestrium et fluviatilium, seu animalium infusorium, helminthicorum, et testaceorum, non marinorum, succincta historia. Vol. II. Heineck & Faber, Havniae et Lipsiae. <https://doi.org/10.5962/bhl.title.12733>
- PAULUCCI M. 1882. Note malacologiche sulla fauna terrestre e fluviale dell'isola di Sardegna. *Bullettino della Società Malacologica Italiana* 8(7–24): 139–381.



- PAULUCCI M. 1886. Fauna Italiana. Comunicazioni malacologiche. Articolo nono. Conchiglie terrestri e d'acqua dolce del Monte Argentaro e delle isole circostanti. *Bullettino della Società Malacologica Italiana* 12(1-4): 5-64.
- PIEŃKOWSKA J. R., MANGANELLI G., GIUSTI F., BARBATO D., HALLGASS A., LESICKI A. 2019. Exploration of phylogeography of *Monacha cantiana* s. l. continues: the populations of the Apuan Alps (NW Tuscany, Italy) (Eupulmonata, Stylommatophora, Hygromiidae). *ZooKeys* 814: 115-149. <https://doi.org/10.3897/zookeys.814.31583>
- PILSBRY H. A. 1908. Oleacinidae, Ferussaciidae. In: TRYON G. W., PILSBRY H. A. *Manual of Conchology, Second Series: Pulmonata*, Academy of Natural Sciences, Philadelphia, 19 (76): 193-366, i-xxvii.
- PORRO C. 1838. *Malacologia terrestre e fluviale della Provincia Comasca*. Guglielmini e Redaelli, Milano. <https://doi.org/10.5962/bhl.title.12948>
- PULTENEY R. 1799. Catalogues of the birds, shells, and some of the more rare plants, of Dorsetshire. From the new and enlarged edition of Mr. Hutchins's history of that county. Nichols, London.
- ROTH J. R. 1855. Spicilegium molluscorum orientarium annis 1852 et 1853 collectorum. *Malakozoologische Blätter* 2: 17-58.
- SCHILEYKO A. A. 1998a. Treatise on recent terrestrial pulmonate molluscs. Part 1. Achatinellidae, Amastridae, Orkulidae, Strobilopsidae, Spelaeodiscidae, Valloniidae, Cochlicopidae, Pupillidae, Chondrinidae, Pyramidulidae. *Ruthenica*, Supplement 2: 1-127.
- SCHILEYKO A. A. 1998b. Treatise on recent terrestrial pulmonate molluscs. Part 2. Gastrocoptidae, Hypselostomatidae, Vertiginidae, Truncatellinidae, Pachnodidae, Enidae, Sagdidae. *Ruthenica*, Supplement 2: 129-261.
- SCHILEYKO A. A. 1999. Treatise on recent terrestrial pulmonate molluscs. Part 4. Draparnaudiidae, Caryodidae, Macrocyclidae, Acavidae, Clavatoridae, Dorcasiidae, Sculptariidae, Corillidae, Plectopylidae, Megalobulimidae, Strophocheilidae, Cerionidae, Achatinidae, Subulinidae, Glessulidae, Micractaeonidae, Ferrussaciidae. *Ruthenica*, Supplement 2: 453-564.
- ŠTAMOL V., MANGANELLI G., BARBATO D., GIUSTI F. 2018. *Hypnophila zirjensis* n.sp., a new azecid land snail from the Croatian island of Žirje (Gastropoda: Pulmonata: Orthurethra). *Journal of Conchology* 43: 1-14.
- SWOFFORD D. L. 1998. PAUP*. *Phylogenetic Analysis Using Parsimony (and Other Methods) (Version 4)*. Sinauer Associates, Sunderland (Massachusetts).
- TAMURA K. 1992. Estimation of the number of nucleotide substitutions when there are strong transition-transversion and G+C-content biases. *Molecular Biology and Evolution* 9: 678-687.
- THIELE J. 1931. *Handbuch der systematischen Weichtierkunde*. Erster Band. Teil 2. Fischer, Jena, pp. 377-778.
- THOMPSON J. D., HIGGINS D. G., GIBSON T. J. 1994. CLUSTAL W: improving the sensitivity of progressive multiple sequence alignment through sequence weighting, position-specific gap penalties and weight matrix choice. *Nucleic Acids Research* 22: 4673-4680. <https://doi.org/10.1093/nar/22.22.4673>
- WADE C. M., MORDAN P. B., CLARKE B. 2001. A phylogeny of the land snails (Gastropoda: Pulmonata). *Proceedings of the Royal Society B: Biological Sciences* 268: 413-422. <https://doi.org/10.1098/rspb.2000.1372>
- WATSON H. 1920. The affinities of *Pyramidula*, *Patulastra*, *Acanthinula*, and *Vallonia*. *Proceedings of the Malacological Society of London* 14: 3-30.
- WELTER-SCHULTES F. 2012. *European non-marine molluscs, a guide for species identification*. Bestimmungsbuch für europäische Land- und Süßwassermollusken. Planet Poster Editions, Göttingen.
- WESTERLUND C. A. 1902. *Methodus dispositionis conchyliorum extramarinorum in Regione palaeartica viventium, familias, genera, subgenera, et stirpes sistens*. *Rad Jugoslavenske Akademije Znanosti i Umjetnosti, Matematičko-Prirodoslovni Razred* 151(32): 82-139.
- ZILCH A. 1959. Gastropoda. Euthyneura. In: O. H. SCHINDEWOLF (ed.). *Handbuch der Paläozoologie*, 6 (Lieferung 2). Borntraeger, Berlin, pp. 201-400.

Received: October 10th, 2019

Revised: October 31st, 2019

Accepted: November 3rd, 2019

Published on-line: December 14th, 2019

