

Cavitation reactor installation for processing hydrocarbon

A. Tselischev, M. Loriya, A. Ijagbuji

*Volodymyr Dahl East Ukrainian National University,
e-mail addresses: atp00@ukr.net, atp01@ukr.net, dejijagbuji@yahoo.com*

Received June 10.2016; accepted June 20.2016

Summary. This paper proposes a new, simple and an efficient method for methanol formation under the cavitation influence of hydrogen-peroxide using a dynamic cavitation reactor. The process involves the reaction of the generated hydroxyl radical with propane-butane gas (C₃–C₄) to form propyl and butyl radicals which decompose into methyl radicals and alkenes, followed by the subsequent yield of methanol (via the interaction of methyl-radical with hydroxyl radical). Technological process parameters employed in this investigation are quite achievable for industrial production.

Key words: Propane-butane gas, hydroxyl radical, dynamic cavitation, hydrogen peroxide solution.

INTRODUCTION

Owing to the rapidly increasing cost of hydrocarbon raw materials, the industrial enterprises of Ukraine are forced to reconsider the use of hydrocarbons as raw materials for fuel production. According to many experts [1–2], the heat energy expended must be obtained from renewable energy sources, and it is believed that hydrocarbon feedstocks should be applied for the synthesis of organic products such as methanol, acetic acid, synthetic oils, plastics, and etc. This approach will efficiently enhance the use of hydrocarbon feedstocks, as well as significantly reduce Ukraine's dependence on energy.

It is note-worthy that in the petroleum refining process [3], a substantial amount of C₃–C₄ gas (existing as a mixture rather than individual component), is recovered from primary crude oil distillation and by catalytic cracking of heavy molecules; bulk of which is flared through the refinery-furnace into the atmosphere due to the lack of processing facility in the production field. Given the higher chemical reactivity of propane and butane molecules compared to methane, and because the C₃–C₄ gas is practically a waste during refining process, the use of a C₃–C₄ gas as an alternatively cheap source of raw materials for methanol production appears very promising. However, a major problem appears to be the activation of propane and butane molecules (as well as other alkanes) under normal conditions. The activation process for alkanes requires large amounts of energy, and largely determines the economic performance of most chemical and petrochemical industries. Therefore, finding cost-effective ways to activate alkanes under

"soft" conditions (at a temperature of 100⁰ C, and at an atmospheric pressure P = 1 atm.) is an important and urgent task [4–6]. This direction would allow to the synthesis of quite a number of important chemical products such as methanol, in a simple and efficient way compared to the conventional technology.

The importance of atmospheric reactions is supported by the high reactivity of the hydroxyl radical, which provides activation of such inert molecules like methane. The sink of methane in the upper troposphere is realized by reaction with the hydroxyl radical [7]. From a number of studies devoted to alkane oxidation by hydroxyl radical, it has been demonstrated that hydroxyl radical is a key reactive intermediate in both combustion [8–12] and tropospheric free-radical chemistry [13–18] of hydrocarbons.

Conventional technologies for the conversion of methane into alternative fuels such as the initial conversion of methane to syn-gas at a temperature of about 850⁰C and a pressure of 4 MPa [1, 19], followed by the high-pressure catalytic conversion of syn-gas to methanol are energy-intensive, less-efficient and not cost-effective mainly due to the limitations imposed by the reaction equilibrium and low heat efficiency [20].

Considering the above, the relevance of this work involving the creation of a new and an efficient technology for the production of basic organic products [21] with the initial formation of hydroxyl radical, and subsequently methanol in particular, is undoubtful.

One of the promising directions for the industrial implementation for methanol production is via cavitation method, and the driving force behind the proposed process involves the dynamic cavitation of hydrogen peroxide [22–23]. In order to carry out this process, it is expedient to implement a design mechanism for hydroxyl radical generation in a cavitation reactor [24]. To ensure a subsonic-flow, the calculation of the basic parameters such as the nozzle-hole diameter, the linear flow-rate, and the pressure-drop of the reactant-mixture across the injector were performed.

The main objective when designing the cavitation reactor involves the calculation of the shape and size of nozzle to determine the laval nozzle flow. To calculate the nozzle-hole diameter, the flow-rates of reaction-mixture through the nozzle must be pre-determined. To do this, we made use of *Navier-Stokes* equation for describing the motion of fluids as shown below [23]:

$$P_1 + \frac{\rho v_1^2}{2} = P_2 + \frac{\rho v_2^2}{2}, \quad (1)$$

where: P_1, P_2 – pressure before and after nozzle injection, (MPa);

v_1, v_2 – flow-rate before and after nozzle injection, (m/s);

ρ – fluid density (kg/m^3).

From Equation (1), the dependence of pressure (P_2) on the flow rate (v_2) after the injection nozzle is determined, and shown in Equation (2):

$$P_2 = P_1 + \rho \frac{v_1^2 - v_2^2}{2}. \quad (2)$$

Dependence graph of pressure (P_2) on the flow-rate of nozzle (v_2) is shown in Fig. 1. At a mass flow-rate of 140 m/s [24], the pressure after nozzle-injection (P_2) reaches a point where cavitation starts. This speed allows to calculate the value of nozzle diameter to be equals ~ 0.7 mm, at a pump pressure in nozzle ($P_1 = 16$ MPa), and feed flow-rates of 3.5 – 5.0 L/min. To do this, we use the formula:

$$F = v_2 S, \quad (3)$$

where: F – flow-rate through the nozzle, m^3/s ;

V_2 – flow-velocity, m/s;

S – cross sectional area of nozzle opening, m^2 .

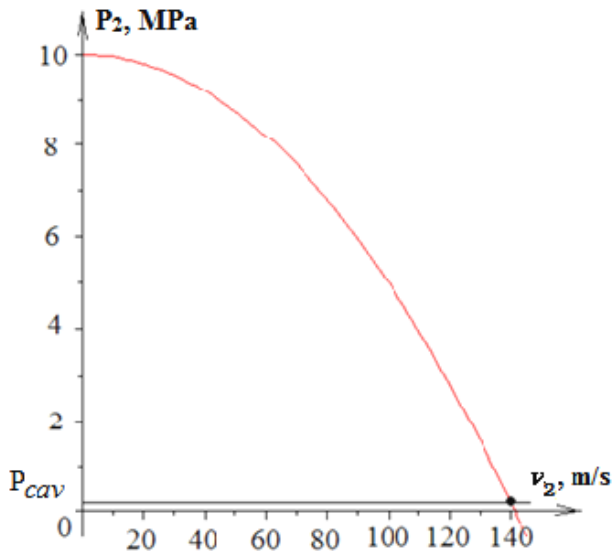

Fig. 1 Dependence graph of pressure (P_2) on the flow-rate of nozzle (v_2)

Given that $S = \pi d^2/4$ from equation (3), then the diameter of the nozzle-hole may be determined, which is calculated to be equals 0.7 mm.

Therefore, by using laval subsonic-flow of nozzle with a diameter of 0.7 mm, and at a pressure above 110

atm., hydrogen peroxide, under the action of dynamic-cavitation decomposes into two hydroxyl radicals.

From the results analysis in work [24], it can be concluded that a mass flow-rate of 140 m/s, the pressure after nozzle injection reaches a point where the cavitation starts. The value of flow-velocity (140 m/s) and the nozzle diameter (~ 0.7 mm) at a pump pressure in nozzle ($P_1 = 16$ MPa) allow to calculate the feed flow-rates to be equals 3.2 L/min, but equals 7 L/min., at a nozzle diameter of ~ 1.0 mm.

The reactor is shown schematically in Fig. 2. It consists of two parts: the top (1) and bottom (2) of the reactor, which are interconnected with a flange (3) via pins (9) as pivots to hold the cavitation chamber. The reactor lid (10) is mounted on a threaded inlet pipe connecting the high pressure line. At (5) is the high-pressure inlet line. The flow across the main line are impeded by sharp-edged constriction (6) such that the local velocities suddenly rise due to reduction in the flow area resulting into lower pressures which is below the liquid vapor-pressure. Consequently, the liquid flow turns into a fog-like substance which is very well-mixed with the gas-stream of hydrocarbon material fed into the reactor via the outlet (11) (if the hydrocarbon feed gas is methane, propane, butane). The inlet and outlet openings are fitted with a mesh-grille (7) so that the the reaction mixture passes through it into the diffuser (8) in order to create conditions for liquid-phase condensation. The liquid flow at high velocity entering the tank ensures uniform-mixing of the reactant mixture due to intense circulation-currents generated in the tank. The liquid and gaseous reaction products were discharged from the reactor through the nozzle located at the reactor bottom (2) and then directed to the separator. The resulting products were collected at the tank (8), and thereafter separated into their individual components.

The reactor can also operate on liquid raw material such as gasoline and diesel. In this case, the raw material and hydrogen peroxide solution are fed together into the nozzle (5). The Fitted lid and the high-pressure inlet line allow the movement of nozzles (5) with respect to the conical interference (6) with a view to determining the optimum parameter range of the inner diameter during the cavitation processes, which are experimentally-obtained to be within 3 – 5 mm [24].

The paper presents the proposed experimental setup (Fig. 3) for methanol production from propane-butane gas using cavitation reactor, which operates as follows: A predetermined concentration of hydrogen peroxide solution are fed through the high-pressure inlet, and then supplied into the reactor using the control valve (1). The resulting mixture are then throttled down using a 3 mm centrifugal pump/nozzle (4) as the fuel injection system into the cavitation reactor at 16 MPa. Liquid with pressure up to 30 MPa and at a flow rate of 5 L/min reaches the nozzle (5). Using the nozzle (5), a static pressure-flow occur which subsequently leads to the cavitation of the liquid stream.

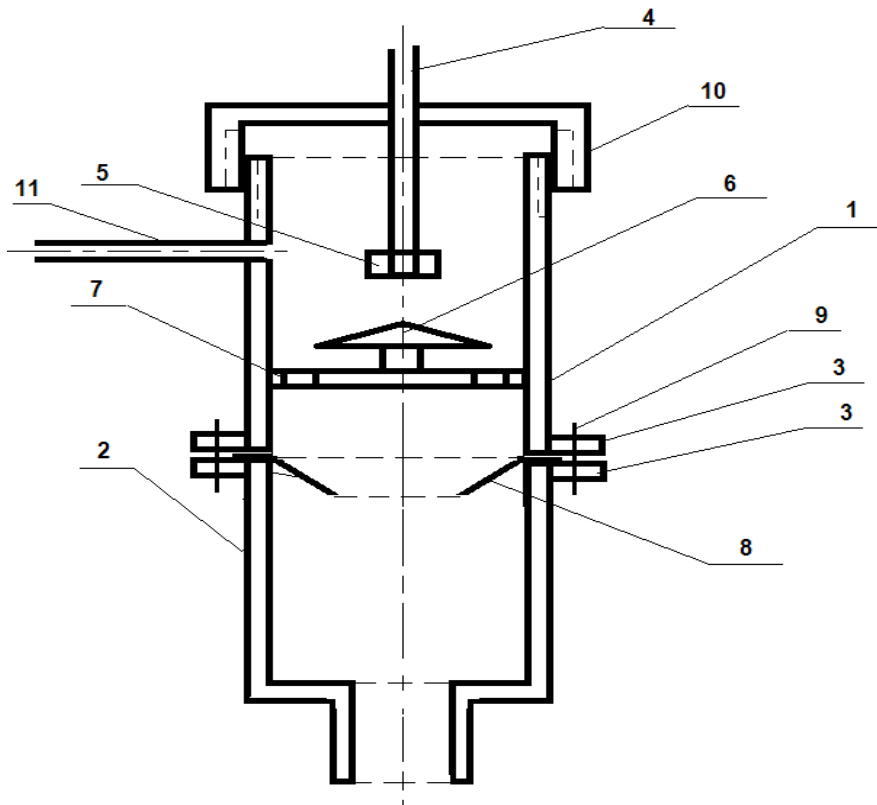

Fig. 2. Cavitation Reactor for Hydrocarbon Processing: 1, 2 – Upper and lower part of reactor; 3 – Flange; 4 – High-pressure inlet line; 5 – Nozzle; 6 – Cone-shaped obstacle; 7– Mesh grille; 8 – Diffuse; 9 – Pin; 10 – Cover; 11 – Union

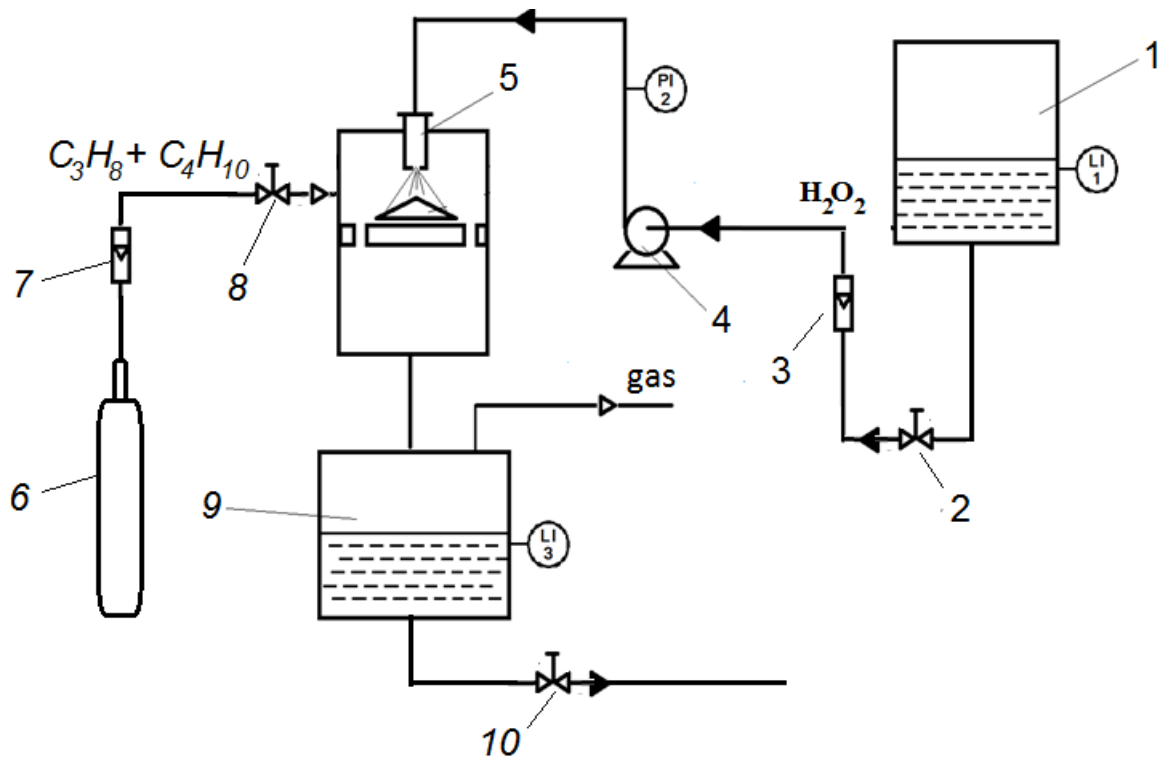
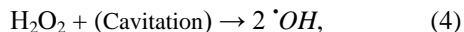

Fig. 3. Schematic of the Dynamic Flow Reactor System: 1 – vessel with solution of hydrogen peroxide; 2,7 – High-pressure pump; 3,8,10 – control valve, 4 – rotameter, 5 – nozzle, 6 – cylinder of propane-butane gas; 9 – container for the reaction products [25]

Propane-butane gas is fed into the reactor via the tank 6 through the flowmeter (7) and the control valve (8). In the reactor, following processes are observed.

In the first stage, hydrogen peroxide, under the action of cavitation dynamic decomposes into two hydroxyl radicals [24]:



Upon the interaction of the generated hydroxyl radical ($\cdot\text{OH}$) with an alkane molecule, hydroxyl radical cracking. In terms of this process [25, 26], the selectivity of formation of $\cdot\text{CH}_3$ is certain:

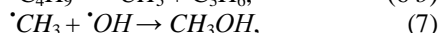
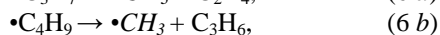
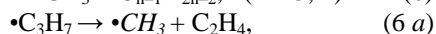
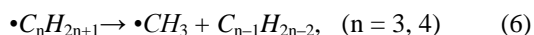

From the reactor outlet, the reaction products are discharged into the receptacle (9), and are subsequently selected for analysis through the valve (10). If gas conversion is low, the unreacted gas-fraction can be re-fed back into the reactor through the input processing circuit. Analysis of the liquid and gaseous reaction products is

removed. The feed flow-rate of hydrogen peroxide solution was 5 L/min, but was varied from 0 to 100 L/min for propane-butane gas. Pressure at reactor

reaction proceeds by hydrogen atom abstraction from the C–H bond to form alkyl radicals and water molecules:

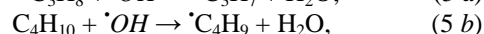
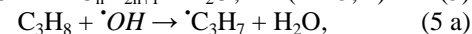
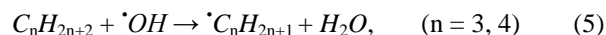

Whereas, the subsequent homolytic decomposition of C–C alkyl radical to form methyl radical and alkene molecule (in our case – C_2H_4 и C_3H_6) is a well-known radical-chain process in thermal carried out by chromatography using LKhM-8 GC of 3 m POLYSORB and CLARUS-500.

This flow chart (in Fig. 3) can be used for processing as gaseous and liquid hydrocarbons. If the hydrocarbons are in the liquid state such as low-octane gasoline, the control valve (1) of cavitation reactor overlaps and the hydrocarbon feed stream from vessel (8) is mixed with hydrogen peroxide solution from tank (7) using the high pressure pump (6). The resulting products were collected at the tank and thereafter separated into their individual components i.e. the liquid products were collected at container but the gaseous products from container may either be flared, or sent to separation capacity (9), whereas the hydrocarbon phase is inlet (before nozzle) was also varied within the range of 0 to 30 MPa [27].

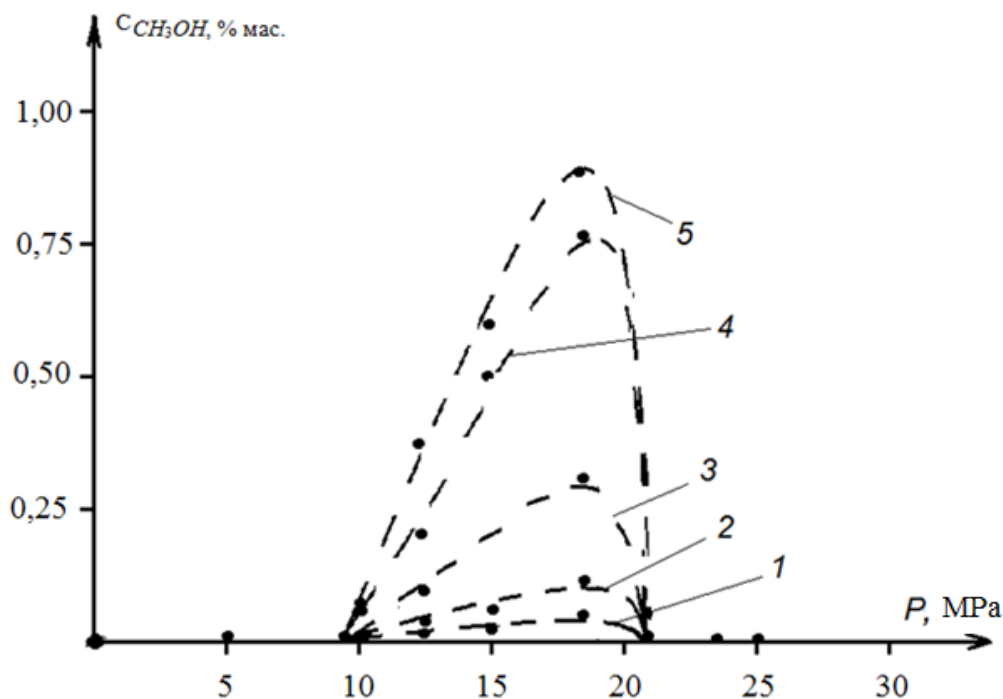

Fig. 4. Dependence of methanol concentration on pressure:

1 – $Q(\text{H}_2\text{O}_2) = 0\%$; 2 – $Q(\text{H}_2\text{O}_2) = 3\%$; 3 – $Q(\text{H}_2\text{O}_2) = 5\%$; 4 – $Q(\text{H}_2\text{O}_2) = 10\%$; 5 – $Q(\text{H}_2\text{O}_2) = 20\%$ [25]

The dependence of methanol concentration on the pressure from the reaction of propane-butane gas with hydrogen-peroxide solution in the cavitation reactor is shown in Fig. 4. From the results presented in Fig. 4, it can be concluded that: At a pressure lower than 9 MPa, the nozzle flow-rate is less than 140 m/s. Thereby, the decomposition of hydrogen-peroxide solution, the formation of hydroxyl-radical, and methanol are not observed. At a pressure between 10 – 20 MPa, methanol concentration increases with increase in the concentration of hydrogen-peroxide which tends to be maximum at a pressure of 19 MPa. A pressure above 20 MPa has negative impact on methanol yield i.e the liquid's boiling process starts due to throttling effect. At a pressure greater than 23 MPa, hydrogen-peroxide is converted to steam and therefore, neither the dissociation of hydrogen-peroxide solution into hydroxyl-radical nor methanol formation is observed. Conclusively, increasing the concentration of hydrogen peroxide to 20 wt. % and the pressure to approximately 19 MPa, the methanol yield increases to about 1 wt. % which is 50 times higher compared to the methanol concentration under water's cavitation effect. With a further increase in the concentration of hydrogen-peroxide, a rise in methanol concentration unnoticeable. Thus, it can be argued that use of hydrogen-peroxide solution with a concentration of 10 – 20 % wt. is optimal for cavitation process. The calculated degree of propane-butane conversion to methanol equal 5.56 % per pass. The oxidation-products are methanol (major), as well as ethylene and propylene (by-products). In view of the low conversion-rate of propane-butane gas, the gaseous by-products may be recycled via the cavitation unit for further conversion.

CONCLUSIONS

In this work, a new and technological-viable approach for methanol synthesis under the effect of hydrogen peroxide has been investigated using a dynamic cavitation reactor. The following important conclusions can be drawn from this study:

1. The use of hydrogen peroxide solution is simple, environmentally-benign, and economically-attractive. In addition, hydroxyl radical (*obtained via the cavitation of hydrogen peroxide solution*) possesses a tremendous oxidizing influence on alkane molecules;

2. In addition to methanol formation, the presence of low-molecular weight alkenes (e.g. *ethylene* and *propylene*: both considered important starting materials in the petrochemical and refining industries) were observed;

3. Hydrogen-peroxide solution with a concentration of 20% wt. and a reaction pressure of approximately 19 MPa are optimal operating conditions for obtaining the maximum yield of methanol (~ 1% wt.);

4. The proposed experimental set-ups provide a great flexibility in terms of operating conditions (pressure control inlet, the inlet flow rate and temperature). Thus, depending on the application and requirements, geometry and operating conditions may be selected in the dynamic cavitation reactor; Therefore, the proposed methodology in this work is deemed as energy-efficient, cost-effective, environmentally friendly, and can serve as a useful guide for the development of the industrial plan for large-scale

conversion of propane-butane fraction in methanol. In our view-point, the broad consistency between the theoretical concepts and the experimental results makes the proposed method extremely interesting for further research.

REFERENCES

1. **Speight J.G., Özüm B. 2002.** Petroleum refining processes, Marcel Dekker Inc., New York, USA, 2002.
2. **Shilov A.E. 2000.** Activation and catalytic reactions of saturated hydrocarbons in the presence of metal complexes / A. E. Shilov, G. B. Shul'pin. – Dordrecht: Kluwer Academic Publishers, 2000. – 232.
3. **Fokins A.A. 2002.** Selective alkane transformations via radicals and radical cations: Insight into the activation step from experimental theory / A. A. Fokins, P. R. Schreiner // Chemical Reviews. – 2002. – Vol. 102, Issue 5. – 1551–1594. doi: 10.1021/cr000453m
4. **Monks S.P. 2005.** Gas-phase radical chemistry in the troposphere / S.P. Monks // Chem. Soc. Rev., 2005. 34, 376–395.
5. **Jiang H., Gong H., Yang Z., Zhang X., Sun Z. 2002.** Reaction Kinetic and Catalysis Letters, 2002, 75, № 2, 315 – 321.
6. **Zakharov I.I., Ijagbuji A.A., Tselishev A.B., Loriya M.G., Fedotov R.N. 2015.** The new pathway for methanol synthesis: Generation of Methyl Radicals from Alkanes, Journal of Environmental Chemical Engineering, 3 2015, 405-412.
7. **Wang X., Wang J., Guo W., Wang C.** Degradation of rhodamine B in an aqueous solution using swirling jet-induced cavitation combined with H₂O₂, Journal of Hazardous Materials 2009, 169, 486-491.
8. **Tselishev A.B.** Analysis of the methods for alkane activation under mild condition / A.B. Tselishev, I.I. Zakharov, M.G. Loriya, A.A. Ijagbuji, // Issues of Chemistry and Chemical Technology. –2012. –№ 2. – 39-44.
9. **Atkinson R., Perry R.A., Pitts Jr. J.N.,** Rate constants for the reaction of the OH radical with CH₃SH and CH₃NH₂ over the temperature range 299–426 K, J. Chem. Phys. 66 (1977) 1578.
10. **Cox R.A., Sheppard D.** Reactions of OH radicals with gaseous sulphur compounds, Nature 284 (1980) 330–331, doi:http://dx.doi.org/10.1038/284330a0.
11. **Lee J.H., Tang I.N.** Absolute rate constants for the hydroxyl radical reactions with ethane, furan, and thiophene at room temperature, J. Chem. Phys. 77 (1982) 4459-4463.
12. **Atkinson R., Perry R.A., Pitts Jr. J.N.** Rate constants for the reaction of OH radicals with COS, CS₂ and CH₃SCH₃ over the temperature range 299–430 K, Chem. Phys. Lett. 54 (1978) 14-18.
13. **Kurylo M.J.** Flash photolysis resonance fluorescence investigation of the reaction of OH radicals with dimethyl sulfide, Chem. Phys. Lett. 58 (1978) 233-237.

14. **Atkinson R., Pitts Jr. J.N., Aschmann S.M.** Tropospheric reactions of dimethyl sulfide with NO₃ and OH radicals, *J. Phys. Chem.* 88 (1984) 1584-1587.
15. **Sittig M.** 1970. Processes of hydrocarbons oxidation / M. Sittig. –M.: Chemistry, –1970. –300.
16. **Chellappa A.S., Fuangfoo S., Viswanath D.S.** Homogeneous oxidation of methane to methanol: effect of CO₂, N₂, and H₂ at high oxygen conversions, *Ind. Eng. Chem. Res.* 36 (1997) 1401–1409, doi:http://dx.doi.org/10.1021/ie960666v.
17. **Ingold K.** 1973. Theoretical bases of organic chemistry / K. Ingold. –M.: Mir, –1973. –1055.
18. **Shah Y.T., Pandit A.B., Moholkar V.S.** Cavitation Reaction Engineering, New York, Kluwer Academic/Plenum Publishers, 1999.
19. **Abramovich G.N.** 2008. Applied gas dynamics, Nauka, Moscow, 1991. Breshev V., Fil P. 2008. The concept of creating non-contact drive for working bodies in machines of various purpose / Breshev V., Fil P. // TEKA. Commission of Motorization and Power Industry in Agriculture, Poland. – Lublin: Polish Academy of Sciences Branch in Lublin, 2008. – V. VIII A, 126-133.
20. **Breshev V., Fil P., Boyko G.** 2010. Structural synthesis and design variants for non-contact machine drives / Breshev V., Fil P., Boyko G. // TEKA. Commission of Motorization and Power Industry in Agriculture, Poland. – Lublin: Polish Academy of Sciences Branch in Lublin, 2010. – V. XB, 77-86.
21. **Tselishev A.B., Zakharov I.I., Loriya M.G., Ijagbuji A.A., Eliseev P.I., Nosach V.A.** 2014. Motor fuel: Cavitation method for improving its quality // *Chemical Industry of Ukraine* (2014) –№ 2(121), 39-42.
22. **Tselishev A.B.** 2015. Physicochemical basis for the cavitation-cracking of C₃–C₄ alkanes into methanol / A.B. Tselishev, M.G. Loriya, P.I. Eliseev, V.A. Nosach, A.A. Ijagbuji, R.N. Fedotov // *Eastern European Journal of Enterprise Technologies* (2015) –№ 6/6(78), – 48-52.
23. **Loriya M.G., Ijagbuji A.A., Tselishev A.B., Zakharov I.I.** 2013. Autocatalytic photo-oxidation process of C₃–C₄ fraction to methanol // *Advanced Materials Research* (2013) –Vol. 660, 51-56.
24. **Tselishev A.B.** 2015. An efficient-method for improving gasoline quality / A.B. Tselishev, A.A. Ijagbuji, M.G. Loriya // *Advances in Engineering Research* –2015. Vol. 11, Ch. 8, – 145–168, New York, USA.

КАВИТАЦИОННАЯ УСТАНОВКА ПЕРЕРАБОТКИ УГЛЕВОДОРОДОВ

А. Целищев, М. Лория, А. Иджагбуджи

Аннотация. Разработан способ синтеза метанола из алканов с использованием динамической кавитации перекиси водорода, который характеризуется простотой и достаточной эффективностью. В основу способа положено взаимодействие гидроксильного радикала с пропан-бутановым (C₃–C₄) газом с образованием пропил- и бутил- радикалов и последующим получением метанола и разработке на их основе новой технологии неполного окисления алканов в метанол в «мягких» условиях.

Ключевые слова: гидроксильный радикал, пропан-бутановый газ, метил-радикал, кавитация, метанол.