Joanna Rut[✉], Marian Bartoszek[✉]

Opole University of Technology

Acquisition, transmission and management of data in industrial practice in the digital age

Pozyskiwanie, przekazywanie i zarządzanie danymi w praktyce przemysłowej w erze cyfrowej

Abstract: Digital technologies permeate all aspects of industrial production and Logistics systems, accelerating the generation of large amounts of industrial data. Industry 4.0 and Industrial Internet of Things offers great development opportunities, new perspectives, a new paradigm of autonomous and decentralized production control. The information on the current status of industrial processes is invaluable in present times. Among others, it enables deliberate and rational management of available resources. Therefore, acquisition, transmission and management of data is an important issue in the systems for collecting data from production lines and a key element in the decision-making process. In industrial practice, the data acquisition process uses the information obtained from various sensors placed directly in production lines. The current level of microelectronics development enables acquisition and transfer of data from technological processes in real time. This article presents selected popular methods of automatic acquisition and transfer of data directly from production lines in the course of implementation of manufacturing processes. A review of all the issues discussed is supported by examples. Particular attention is paid to the nature and importance of data acquisition in the decision-making process. It was emphasized that the information itself is very important, but the value of information and the way it is processed and managed are also important. Data management in the unit optimizes the decision-making process and the work of the entire unit. On the other hand, data is a resource, the loss of which may result in the loss of competitive position or the loss of development opportunities.

Key words: digital technologies, data acquisition, data management, production, management, decision-making process, Industry 4.0, automation, sensors, wired network, wireless network

Synopsis: Technologie cyfrowe przenikają wszystkie aspekty produkcji przemysłowej i systemów logistycznych, przyspieszając generowanie dużych ilości danych przemysłowych. Przemysł 4.0 i Przemysłowy Internet rzeczy oferują ogromne możliwości rozwoju, nowe perspektywy, nowy paradygmat autonomicznej i zdecentralizowanej kontroli produkcji. Informacje o aktualnym stanie procesów przemysłowych są nieocenione w dzisiejszych czasach. Umożliwia m.in. przemyślane i racjonalne gospodarowanie dostępnymi zasobami. Dlatego pozyskiwanie, przekazywanie i zarządzanie danymi jest

✉ Joanna Rut – Opole University of Technology; Faculty of Production Engineering and Logistics; Department of Logistics; e-mail: j.rut@po.edu.pl; <https://orcid.org/0000-0001-9014-8874>

✉ Marian Bartoszek – Opole University of Technology; Faculty of Mechanical Engineering; Department of Manufacturing Engineering and Automation; e-mail: m.bartoszek@po.edu.pl; <https://orcid.org/0000-0002-6964-6921>

ważną kwestią w systemach zbierania danych z linii produkcyjnych i kluczowym elementem w procesie decyzyjnym. W praktyce przemysłowej proces pozyskiwania danych wykorzystuje informacje uzyskane z różnych czujników umieszczonych bezpośrednio na liniach produkcyjnych. Obecny poziom rozwoju mikroelektroniki umożliwia pozyskiwanie i przekazywanie danych z procesów technologicznych w czasie rzeczywistym. W artykule przedstawiono wybrane popularne metody automatycznego pozyskiwania i przesyłania danych bezpośrednio z linii produkcyjnych w trakcie realizacji procesów produkcyjnych. Przegląd wszystkich omawianych zagadnień jest poparty przykładami. Szczególną uwagę zwraca się na charakter i znaczenie pozyskiwania danych w procesie decyzyjnym. Podkreślono, że sama informacja jest bardzo ważna, ale ważna jest również wartość informacji oraz sposób jej przetwarzania i zarządzania. Zarządzanie danymi w jednostce optymalizuje proces decyzyjny i pracę całej jednostki. Z kolei dane są zasobem, którego utrata może skutkować utratą pozycji konkurencyjnej lub utratą możliwości rozwoju.

Słowa kluczowe: technologie cyfrowe, pozyskiwanie danych, zarządzanie danymi, produkcja, zarządzanie, proces decyzyjny, Przemysł 4.0, automatyzacja, czujniki, sieć przewodowa, sieć bezprzewodowa

JEL codes: L16, L26, O32, O39

Introduction

Today, digital technologies permeate all aspects of industrial and production systems, accelerating the generation of large amounts of industrial data. Industry 4.0 offers great development opportunities, new perspectives, a new paradigm of autonomous and decentralized production control. From an IT perspective, this means a new level of networking, data integration and data processing in production, and new possibilities for data management. Data management trends and challenges reveal the impact of developing new models and architectures that incorporate the Internet of Things, Cloud Computing and Big Data at different levels of integration to enable intelligent analytics. Data management covers all the plans, processes, policies, and practices that a company uses to collect, store, control, deliver, and modify data and information in the systems of a business organization. Proper data management is one way business can proactively improve the quality, efficiency, effectiveness and reliability of its data [Tupa and Steiner 2019].

Changing market conditions and increasing competition force manufacturing companies to use organizational, technological and IT innovations which enable flexible production planning and increasing efficiency of management of processes. Appropriately collected and presented data from production lines make it possible to specify which of the manufacturing processes reduces productivity and at what point it should be improved.

Data acquisition in industrial practice consists in remote reading data through measuring systems as well as transmission of the data obtained using a transmission medium. The data acquired in this way are usually sent to an acquisition server (Figure 1) or a DNC computer. The constantly growing level of industrial automation causes the dynamic growth of the amount of transmitted data. It should be noticed at the same time that the requirements related to the increase in the amount of the data processed and the reduced time of their acquisition affect parameters of industrial enterprises. The data acquisition is one of the most important issues of distributed real-time systems. Modern computer systems used to support manufacturing processes allow for real-time visualization, processing, downloading and

making available the data collected. In the context of the vast amounts of data on processes, the tasks specified pose a serious problem to be solved by the systems of industrial databases used currently [Cupek 2021].

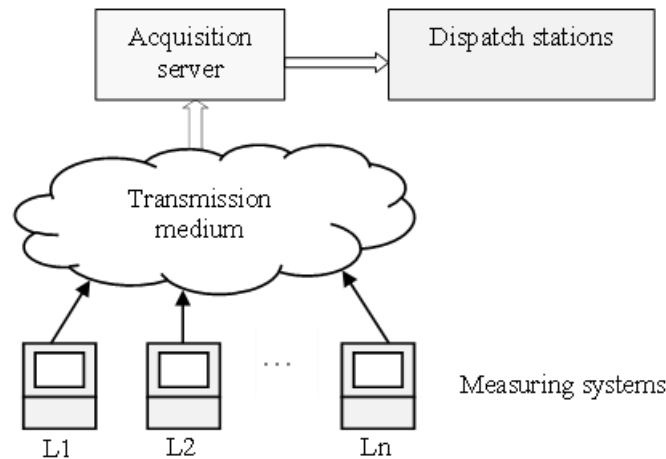

Figure 1. Example of a remote reading system
Rysunek 1. Przykład systemu zdalnego odczytu
Source: [Bogacz and Krupanek 2021].

There are many methods for collecting process data from production systems. In general, it can be said that the choice of an appropriate method depends on specific characteristics and the level of automation of manufacturing processes [Ćwikła 2011]. Acquisition of data from manufacturing processes can be manual, semi-automatic or automatic. The manual acquisition is a process onerous for employees, vulnerable to manipulations and many errors resulting, among others, from the human factor. Moreover, the data in the process of manual acquisition is collected with a huge delay. This is due to the fact that they must be entered manually into the system and forwarded. The semi-automatic acquisition is based on the cooperation between a man and a machine. The semi-automatic mode enhances the process of data acquisition significantly but does not eliminate all deficiencies of the manual mode. The automatic data acquisition may be applied in automated production lines or at workplaces intentionally equipped with various types of data acquisition sensors. Therefore, an automatic data acquisition system must be appropriately built. It is usually the most expensive method of data collection for implementation. However, it is the most efficient and the most reliable of all the methods mentioned above [Sade et al. 2019].

It is obvious that fully automated production systems due to the large amount of the key data on processes affect taking decisions on controlling manufacturing processes. However, the data collected from the sensors require proper analysis and interpretation [Ćwikła 2011]. Finally, it is a man who takes decisions on controlled processes on the basis of the current data.

The aim of this paper is to present selected popular ways and methods of automatic acquisition and transfer of data directly from production lines of enterprises, accentuation the differences between the discussed methods and presenting the essence of data management as the key to the success of many enterprises.

Materials and methods

The purpose of this paper is to present an analysis of selected methods and approaches to automatic data acquisition and transfer directly from the production lines of enterprises, to highlight the differences between the discussed methods and to present the essence of data management as a key to success of many enterprises in the era of digitalization of Industry 4.0. Based on the literature and available data on the acquisition, transmission and management of data, an analysis and evaluation was carried out, resulting in the conclusion that in all manufacturing enterprises, the acquisition and management of data from the production layer serves to increase production efficiency and reliability, and data acquisition is a key element in the decision-making process and at every level of enterprise management. The analysis also covers current technological developments that are increasing the possibilities of wired as well as wireless ways of transferring data from technological processes, accelerating the pace of analysis in the decision-making process, as new technologies used in Industry 4.0 are also enabling the development of enterprises whose main objective is to gain a competitive advantage. Without appropriate support of modern digital technologies, the amount of data/information generated in technological processes, is impossible to process and use in further development of enterprises.

Industry 4.0 and Industrial Internet of Things

Industry 4.0 stands for the integration of intelligent machines, systems and the introduction of changes in production processes to increase manufacturing efficiency and introduce the possibility of flexible product range changes. In line with the idea of the future, data acquisition and archiving are of great use in production processes. The analysis of production data allows for the early elimination of process errors and strategic line failures. The archiving of data allows the creation of historical analyses and direct process tracing of the product at each production stage and supports future production planning [Ak wizycja i transmisja...].

The basic execution elements necessary to move production into the digital era are digitalized control systems. It is about controlling automation systems, production nests, automatic transport or human communication systems. Industrial computers are responsible for the operation of all these devices and they are the main element allowing to build the Industrial Internet of Things, Digital Factory or, finally, to create an enterprise management and control system compliant with Industry 4.0. In industrial installations, measuring devices generate huge amounts of information, e.g., about the condition of machines or environmental conditions. Until now, this data was hardly used because it was not transmitted to the control systems. Nowadays, they can be transmitted via digital techniques to the cloud, where they are available to all systems operating in the plant. This makes it possible to continuously monitor the condition of the equipment and to plan maintenance activities well in advance.

It also makes it possible to optimize production processes, depending on information about conditions, location and availability of individual devices. This results in savings of raw materials and media used during production [Bieńkowski 2018].

Data acquisition – an essential element of the decision-making process

It is in all manufacturing companies that the data acquisition from production processes and the management of the data are aimed at improving productivity and reliability of the processes. Data acquisition is a key element in the decision-making process at every level of business management i.e. from operational services and maintenance through departments of engineering to administrative units. These levels also have their reference in the hierarchical structure of an enterprise. It is at the lowest level that there are the sensors, actuators and various industrial automation devices having a direct connection with the production level. A level above, there are control and data acquisition systems as well as all sorts of industrial control systems. These systems operate in real time and, besides collecting data, are responsible for control of machinery, equipment and components of production lines [Pękala 2012]. The decision-making process consists mainly of stages of identification and analysis of all the information available on the existing problems, then assessment, decisions and selection of an optimal solution [Sala 2007]. Efficient and accurate decision making within a reasonably short period is the basis for the proper functioning of any enterprise [Bolloju et al. 2002]. The complexity of decision-making processes involves many determinants affecting their course. The process itself can be characterized as a set of different elements defining the context and the circumstances of decision-making. The efficiency of decision-making processes depends on the organization of activities and the course of the planned cycle and the need to isolate individual stages results from the complexity of processes themselves [Kisielnicki 2006]. The analysis of the decision-making process enables thorough understanding of the problem and the entire process as well as generates new knowledge [Bolloju et al. 2002].

Data acquisition in the decision-making process is a fundamental prerequisite for solving most problems that occur in the enterprise. In a rational analysis of alternative decisions, an important element is a careful comparison of benefits and costs and possible courses of action and behaviour. Current changes in the surrounding reality, digitalization and Industry 4.0 set new goals and directions that organizations will strive for.

Methods for collecting data from production lines

In the process of data collection from production lines, it is very important that the process data acquisition itself is not burdensome for an operator and does not slow the production process. In industrial practice, the data acquisition process uses many sensors positioned directly in the production line [Xu et al. 2020]. An example of sensors' classification is shown in Figure 2.

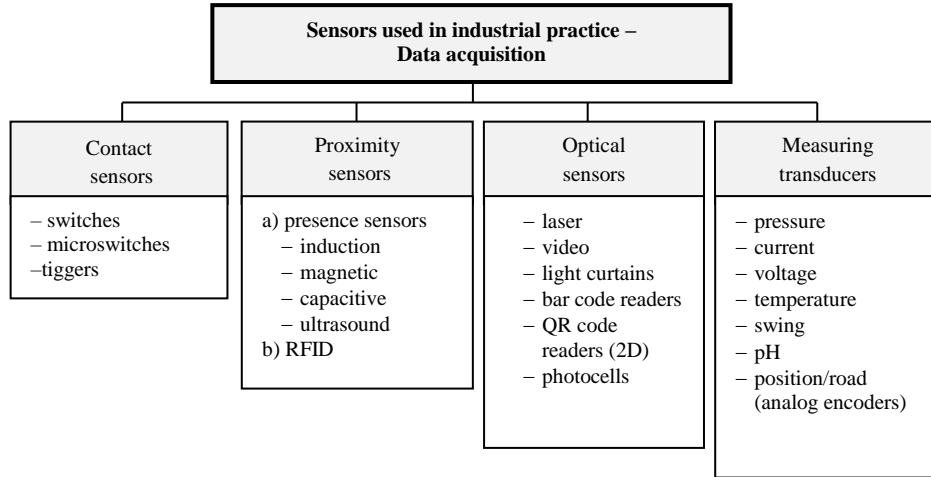

Figure 2. The division of sensors used in industrial practice for collecting data
 Rysunek 2. Podział czujników stosowanych w praktyce przemysłowej do zbierania danych
 Source: own study based on [Fraden 2010].

For obvious reasons, sensors are necessary and are an important element of most machines, equipment and technological lines. They are usually very small and inconspicuous. However, it is without them that it would not be possible to detect the presence of objects, define their characteristics, control work of machinery and equipment as well as processes. Therefore, well-selected sensors largely decide on the accuracy and reliability of production processes [Fraden 2010].

The sensors listed in the Figure 2 usually work together with PLC controllers (PLC – Programmable Logic Controller) (directly connected to input modules, bus connection – Profibus, MPI, ANSI, SPI, I2C, CAN or through an industrial network – Profinet). Acquisition of data from production lines generally consists in collecting data from PLC controllers [Fraden 2010, Blokdyk 2020].

The PLC controllers integrate entire hardware controlling technological processes. Their outputs are connected to executive systems, to inputs – different types of sensors and measuring systems. It is through fast buses that they communicate with other controllers (often specialized for specific tasks). At the same time, they are also equipped with a number of interfaces allowing for communication with data networks, may also be equipped with hardware modules for recording data process directly to standard of databases [Ćwikła 2012].

Contact sensors are mainly used as “limit switches” (position switches), however, due to the presence of mechanical parts in their construction, they are prone to crushes, which causes that they are used less often in industrial practice. Contact sensors are used mainly for detection of the presence of objects which are not deformed by contact. They are also used as triggers – devices starting machines [Fraden 2010].

Proximity sensors belong to main elements of many industrial automation systems. They are used primarily to detect the presence of objects, their count and even to define their certain physical characteristics. The use of proximity sensors allows for automatic control of

machinery and production systems through controlling levels of certain liquids and bulk material, and even for providing personnel with security when they are used in the safety systems [Karbowniczek 2015].

Optical sensors are part of control devices, whose operation is based on sending a light beam by a transmitter which is received by a receiver and recording objects which cross the light beam sent by the transmitters. Optical sensors are characterized by a high resolution which enables to record very small objects, a large detection zone from a few centimeters to several meters, a short response time and high resistance to noise and air pollution. Optical sensors are very widely used in industry. They are used, among others, for [TWT Automatyka]:

- identification of objects within the range of their operation,
- controlling the position of the moving parts of machinery,
- counting passing objects or number of revolutions,
- specifying for example: the level of liquids and bulk material,
- in addition to typical industrial applications, they are also used for control of comings and goings, at gates and security systems.

Measuring transducers convert a tested physical unit (temperature, weight, pressure, pH, moisture) to another one. It is usually that the output unit is current or voltage – a signal read by industrial automation systems [Fraden 2010]. Examples of sensors used in industrial practice are shown in the Figure 3.

Sensors provide a wide range of information on the state and course of the manufacturing process as well as on the condition of machines and devices allowing for automatic manufacturing process control. The main task of sensors used in production lines is collecting data from production paths as well as detecting irregularities occurring in production processes [Fraden 2010]. The data, which can be obtained, cover executed tasks (progress of executed orders), material flow (parts, work in progress, finished products), use of machinery and equipment (performance, downtime, failures), quality of products and the data on persons/workers involved in the production process (type of operations performed, breaks etc.). Selection of types and location of sensors in the automatic process is individual for each production line (specificity of production) and depends on the type of the production process [Xu et al. 2020].

The larger the number of sensors, the more comprehensive may be the control algorithm of the manufacturing process. The most commonly used sensors for data acquisition in industrial automation are inductive sensors (metal detection), capacitive sensors (responding to approach of any active medium to the surface) and photoelectric sensors (allowing for detection of foreign bodies in the operating area, light or color detection) [Heimann et al. 2001].



Figure 3. Exemplary sensors used in the industrial practice: a) a contact sensor (a limit switch); b) an inductive proximity sensor; c) an optical sensor; d) a pressure transducer

Rysunek 3. Przykładowe czujniki stosowane w praktyce przemysłowej: a) czujnik kontaktowy (wyłącznik krańcowy); b) indukcyjny czujnik zbliżeniowy; c) czujnik optyczny; d) przetwornik ciśnienia

Source: a – [Kontratech]; b – [Karbowniczek 2015]; c – [Automatyka – sklep]; d – [ACSE].

The cooperation of an enterprise resource management system with a production subsystem of the company requires certain and unambiguous acquisition of data on the manufacturing process. The data are passed through different types of data networks from the source to the place of their analysis and storage, whose load changes in time. Another problem is the diversity of technical solutions crated as universal or customized solutions. Characteristics essential for the effective data acquisition are consistency of the information, reliable collection and storage, effective access to information and keeping chronology of the events recorded [Cupek 2021].

Methods for transferring data from production lines

The modern methods for transferring data available today offer immense, new opportunities in the processes of automation of technological lines. The data are exchanged via industrial networks, local computer networks, wireless networks or a global computer network. The possibility of connecting via drivers, distributed inputs/outputs modules, transducers, frequency converters, operator panels or PC-es installed locally or anywhere in the world offers a user great opportunities for the full integration of the extensive, distributed industrial processes [Naskręt et al. 2005]. Nowadays, the huge amount of processed and collected data has led to an increase in digital demand using methods and tools that can process data quickly enough and extract valid, relevant, useful and meaningful information from it.

The modern manufacturing companies constantly strive after reduction of production costs, improvement of quality and enhancement of the efficiency of technological processes. Currently, there are many interfaces for data transmission used in processes of production control [Tupa and Steiner 2019, Xu et al. 2020].

Transfer of data from measurement points and from elements in their production process can be carried out either by wire or wirelessly (Figure 4). Network infrastructure is currently an indispensable part of machinery, equipment and production lines allowing for control of machinery, technological processes, data transmission and communication with computer systems of a company [Blokdyk 2020].

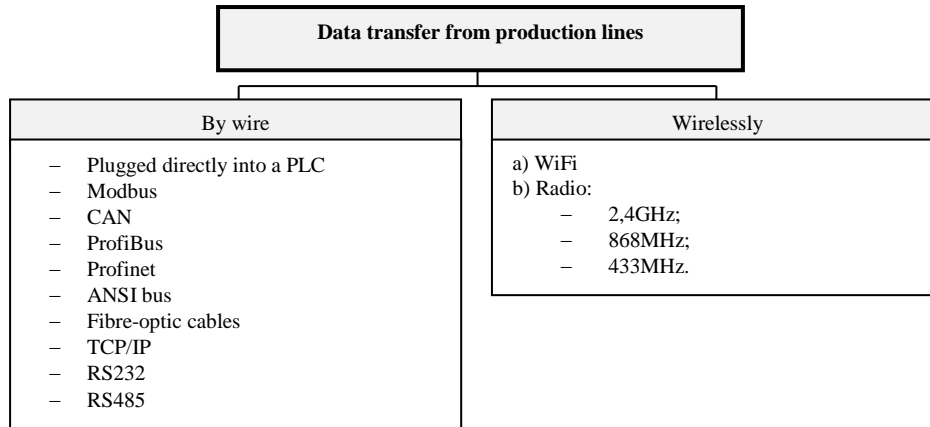

Figure 4. Popular methods for transferring data from production lines used in industrial practice

Rysunek 4. Popularne metody przesyłania danych z linii produkcyjnych stosowane w praktyce przemysłowej

Source: own study based on [Blokdyk 2020].

The optimal efficiency of the data transfer from production lines can be achieved by providing adequate quality of the wired infrastructure, which is a key element in the operation of all machinery and equipment, control systems and industrial automation. Wired data transmission is one of the most popular ways to exchange data in technological processes. The data transmitted in this way can be sent in either analog or digital form with appropriate frequency. This technology is considered to be the most reliable and offers a number of advantages i.e. it is not susceptible to radio interferences, has a higher throughput, ease of diagnosing damage, resistance to serious failures, expandability and can be effectively optimized [Yekini et al. 2015].

Among the many possibilities of transferring data from production lines in a wired way, the ProfiBus network (developed by Siemens), which is used in the distributed control systems, is noteworthy [Mamo et al. 2017]. The network structure is based on the efficient transfer of large amounts of data in real time (data transmission in the network takes milliseconds). Analog and digital (input/output) devices, sensors, actuators, PCS and PLC controllers or operator terminals can be primary stations – controlling stations (Master). The attached substations (Slave) include different systems (i.e. inputs/outputs, cylinders, transducers). The ProfiBus can be operated in either Master-Slave or Multimaster mode. The structure of the ProfiBus protocol is based on the Open Systems Interconnection module (OSI) according to ISO (International Standard Organization). The maximum transmission speed is 12Mbps, the transmission speed is inversely proportional to the length of the bus. There can be up to 127 devices in one network [Mamo et al. 2017].

The Profinet is another noteworthy network. The Profinet network integrates IT networks in enterprises with office networks without modifying existing devices. The basic operation mode is compatible with the TCP/IP protocol. The Profinet network is used, among others, in the systems of the MES and ERP class [Mulaosmanovic 2015].

Moreover, it should be also noted that the standards intended for multipoint transmission lines, i.e. RS232 and RS485, are very important. Both standards are communication buses intended for serial data transmission, the RS232 has a voltage output and RS485 has a current output. Both buses (RS232 and RS485) can work both in full-duplex and half-duplex mode [Mulaosmanovic 2015]. In the full-duplex mode, transmission and reception of data are performed simultaneously; only two devices are connected with each other (Figure 5). The half-duplex mode (Figure 6) consists in transmitting and receiving data alternately (one pair of wires, which is bi-directional).

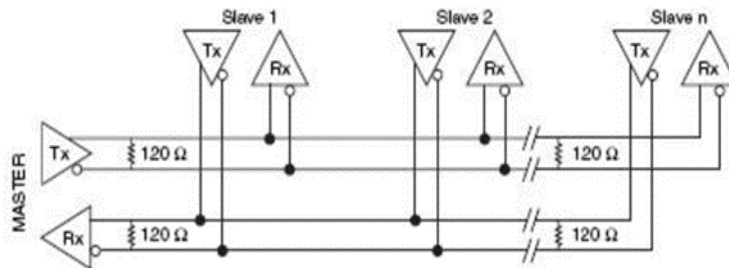

Figure 5. A bus in the Master Slave mode full-duplex
 Rysunek 5. Magistrala w trybie Master Slave full-duplex
 Source: [Engineer Ambitiously].

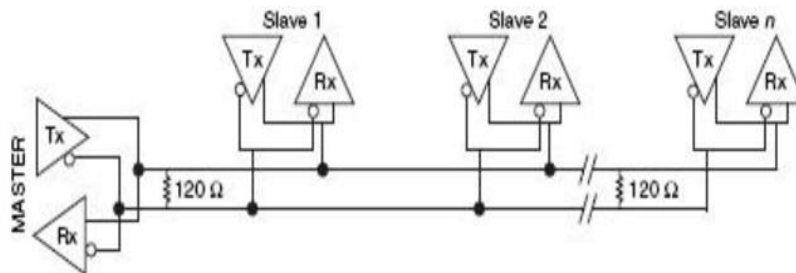

Figure 6. A bus in the Master Slave mode half-duplex
 Rysunek 6. Magistrala w trybie półdupleksowym Master Slave
 Source: [Engineer Ambitiously].

However, the transmission speed drops with the increase in length of the bus (wire). This phenomenon is graphically illustrated in the Figure 7.

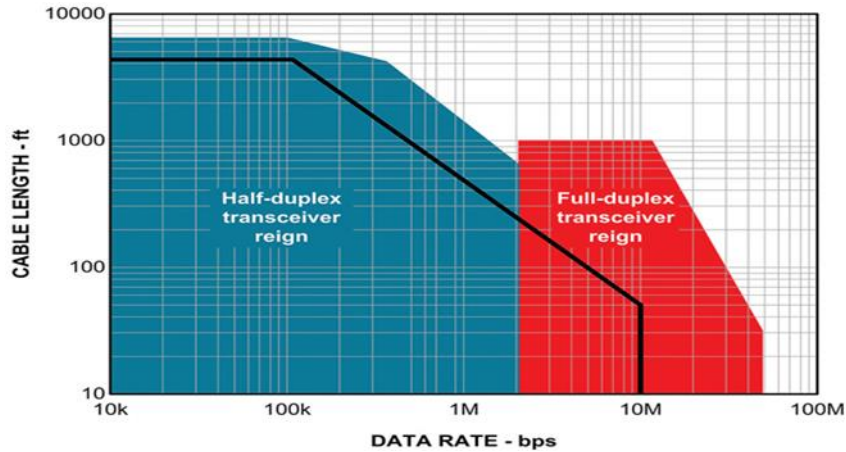

Figure 7. The dependence of the transmission speed on the length of the bus (wires) for the RS485 full-duplex and half-duplex

Rysunek 7. Zależność prędkości transmisji od długości magistrali (przewodów) dla RS485 full-duplex i half-duplex

Source: [Kugelstadt and Devlin-Allen 2014].

Currently, wireless networks are an alternative to conventional wired networks. They are used everywhere, where wired connections are difficult to create or too expensive; they give users easy access to resources regardless of place and time. Wireless data transmission has many advantages, which include the ease of installation and flexibility, monitoring device parameters, range (from several meters in buildings to several kilometers), fast expansion and modification of the network structure. Among disadvantages, there are a high level of external interferences, the requirement of additional security systems, which reduces the speed transmission, unauthorized access, as well as the relatively large energy dissipation [Pawar and Sawant 2014].

There are many possibilities for transferring data wirelessly. One of the most popular network is Wi-Fi, which transmits data on distances to several dozen or several hundred meters and is executed in the IEEE 802.11 standard. Wi-Fi is a technology that is used properly without any modification in the case of industrial applications. Wi-Fi uses the frequency ranges of 2.4 GHz and 5 GHz and the main advantage of this type of transmission is relatively high throughput [Piątek 2021].

Wireless networks are becoming increasingly popular. This technology allows for creation of networks in a variety of different configurations. The most popular and most commonly used is a temporary network (ad hoc) or a network with infrastructure. An ad hoc network is a temporary connection (usually for a short period) amongst devices and computers established for a specific purpose e.g. for direct exchange of files (Figure 8). A network with infrastructure has a fixed master station, in which all devices (in a wireless network) communicate with each other via access points AP (Figure 9) [Pawar and Sawant 2014].

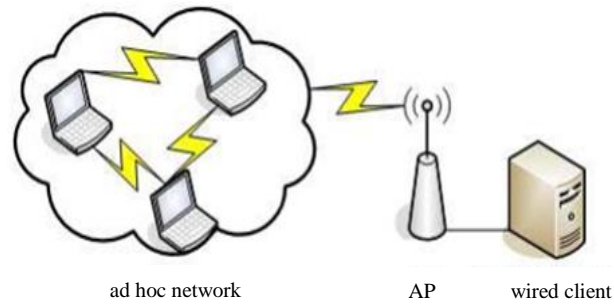

Figure 8. An ad-hoc temporary network (ad-hoc network, wired customer)

Rysunek 8. Tymczasowa sieć ad-hoc (sieć ad-hoc, klient przewodowy)

Source: [Laboratorium lokalnych...].

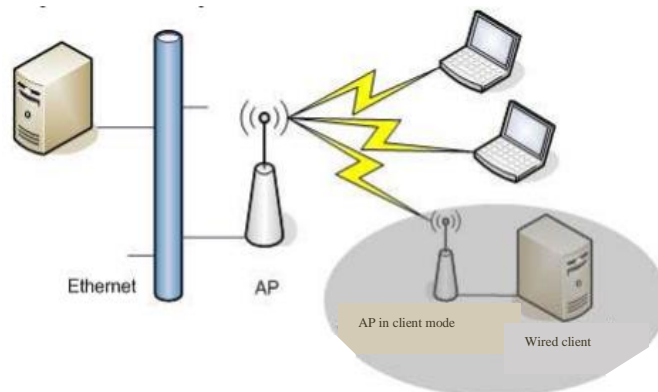

Figure 9. A Network with infrastructure (AP in customer mode, wired client)

Rysunek 9. Sieć z infrastrukturą (AP w trybie klienta, klient przewodowy)

Source: [Laboratorium lokalnych...].

Moreover, other types of networks should be listed such as a bridge point-to-point. This solution is used to connect remote segments of a wired network using radio (Figure 10). It is in practice that a bridge point-multipoint is also used. It is a structure similar to a bridge point-to-point, with the difference that there can be more segments of a wired network connected in this way in this case (Figure 11).

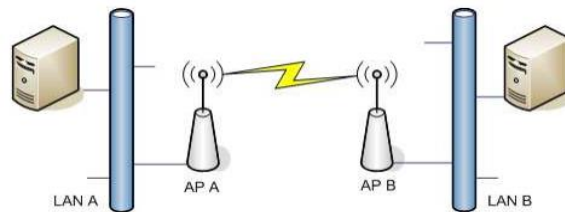

Figure 10. Bridge point-to-point
Rysunek 10. Most z punktu do punktu
Source: [Laboratorium lokalnych...].

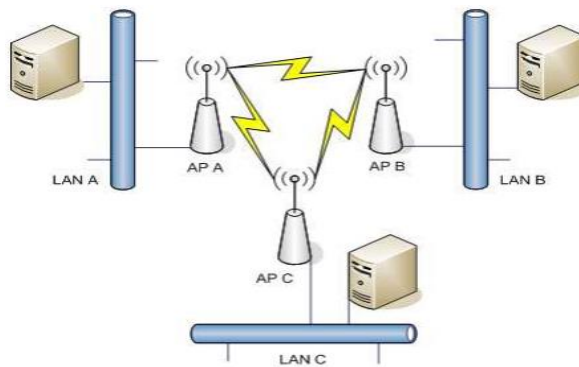

Figure 11. Bridge point to multipoint
Rysunek 11. Most z punktu do wielopunktu
Source: [Laboratorium lokalnych...].

In addition to the different wireless networks mentioned above, it is the MESH network that is noteworthy. This network is considered a smart network. Its intelligence is imbedded in routing algorithms which provide information on the possibility to reach a specific node (Figure 12). MESH networks integrate fully with Internet. Then the IP protocol is accepted as a network layer protocol. However, it should be mentioned that routing protocols in the case of MESH networks are completely different from those used in wired networks [Folga 2006].

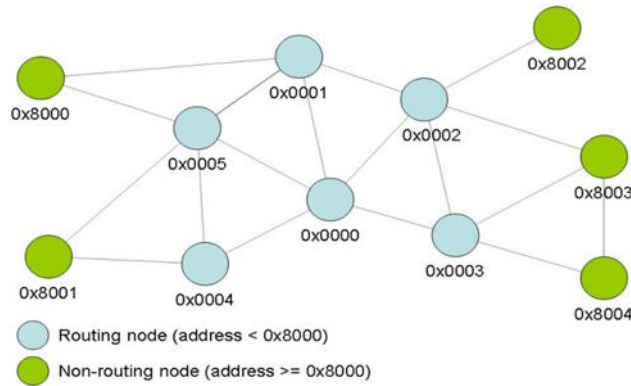

Figure 12. A MESH network
 Rysunek 12. Sieć MESH
 Source: [Rudnicki 2014].

Automated production lines are constructed on the basis of distributed control structures more and more often and therefore require advanced data transmission networks [Antons and Arlinghaus 2021]. The use of the wireless technology based on the Wi-Fi network allows for greater mobility and elimination of wires. The wide availability of technical measures and their differentiated capabilities allow for creation of any form of a network for data acquisition. A comparison of technical characteristics of the selected types of data transmission is shown in the Table 1.

Table 1. A comparison of technical characteristics of the selected types of data transmission
 Tabela 1. Porównanie charakterystyk technicznych wybranych rodzajów transmisji danych

Type of transmission	Data transfer speed	Distance
RS232C	from 300 to 19200 bit/s	max. 15m
RS485	up to 35 Mbit/s	up to 1200m
CAN	up to 1 Mb/s	From 40 m to 1 km
USB	up to 480 Mbit/s, (actual transfer speed depends on the design of the device)	2 to 5 m, with the possibility of extension
Ethernet	from 10 Mbps to 10 Gb/s	from 500 m to 80 km
Wi-Fi	up to 300 Mbit/s	from a few meters to a few km

Source: own study on [Chaładyniak 2011, Kruszyński 2015, Tomaszewski 2018].

To sum up, it should be noted that both solutions wired and wireless can support and complement each other offering a completely new quality of control and monitoring in production processes [Cisco Systems 2007]. They may create so called hybrid systems of transmission networks sending data from technological processes. It is also possible to create redundant networks, in which information may arrive from a sender to a recipient in many ways

(a network automatically chooses the shortest one). The redundancy of transmission paths makes that the network is extremely resistant to failures as in the case of damage to one route, the network selects a different path.

Currently, the development of technology increases possibilities of both the wired as well as wireless data transfer from technological processes and speeds up the pace of analysis in the decision-making process. New technologies used in industry also allow for development of companies, whose main purpose is to generate profit by gaining a competitive advantage. Without proper support of the information technology, the amount of data/information generated in technological processes could not be processed.

Data management – a responsible and complex set of processes

Data collection and management are the foundation for the good functioning of every enterprise. Currently, data is one of the most valuable resources, and their potential is growing. The data obtained is key in the activities of modern enterprises. Thanks to them, all company management processes are optimized [Tupa and Steiner 2019]. However, it is not the information itself that determines their value, but the ways to manage it. How an enterprise uses data determines the quality of data and affects the good (or bad) prosperity of the individual. Data management processes extract all potential from the information. Awareness of the importance of proper data usage currently encourages entrepreneurs to invest in the most effective data management systems. Thanks to detailed analyzes, not only the company's excellent performance is achieved, but also the information flow along with the distribution of access to authorized persons is improved, the offer is perfectly adapted to the customer's requirements and expectations, and the relationship between the company and the customer is improved by improving the service system and communication [Raptis et al. 2019]. Data management also enables accurate analyzes of entire data streams flowing through a given organization, which are subjected to processes recognizing data diagrams. Thanks to the analysis of the stream, the data is immediately filtered and subjected to preparatory activities to use them for a specific purpose. The key to business success is therefore good data management [Integral Solutions].

Conclusion

The aim of the paper was to present selected ways and methods of the automatic data acquisition and transfer directly from production lines, in the course of manufacturing processes and emphasize the importance of the data acquisition in the decision-making process.

Implementation of solutions compatible with the concept of Industry 4.0 gives many benefits, including easy access to data, or the ability to process and present them in a clear and accessible form. Interoperability of devices of Industry 4.0 allows to connect them to the Industrial Internet of Things (IIoT) in any factory environment [Bieńkowski 2018].

The efficiency and cost-effectiveness of production depend on its organization to a large extent. In this sense, the automation and reliability of data collection measurement is of particular importance. It contributes, among others, to reduction of production costs and increase

in productivity, shortening the production cycle, reduction of unplanned and planned downtimes, identification and minimization of errors and inefficient operations. The use of a wide range of different types of sensors allows for acquisition and transfer of data directly from production lines. However, it is not the information itself that provides value, but also the processing and management of data quality. Data management in the organization facilitates not only every data activity, but also optimizes the work of the whole unit. Data is a resource whose potential is in continuous development, which is why companies do not cease to collect them. As it is well known, the knowledge on the current status of the production process is of great importance in the decision-making process. Moreover, the possibility to monitor in the online mode contributes to increasing the productivity and reliability of production.

In conclusion, it should be noted that without consistent high-quality data, companies are exposed to threats such as loss of revenues, loss of valuable development opportunities and damage to their reputation, which can lead to a serious weakening of their market position.

References

- ACSE, [electronic source] <https://www.acse.pl/produkt/335/atmeco-atmecoex-przetworniki-cisnienia-do-pomiaru-cisnienia-cieczy-i-gazow> [access: 22.11.2021].
- Akwizycja i transmisja danych, SolGam, [electronic source] <https://www.solgam.pl/budowa-maszyn-i-automatyzacja-procesow/automatyzacja-procesow/akwizycja-i-transmisja-danych> [access: 22.12.2021].
- Antons O., Arlinghaus J.C., 2021: Distributed control for Industry 4.0 – A comparative simulation study, IFAC-PapersOnLine 54(1), 516–521, <https://doi.org/10.1016/j.ifacol.2021.08.059>.
- Automatyka – sklep, [electronic source] <https://automatyka-sklep.eu/czujniki-optyczne> [access: 28.11.2021].
- Bieńkowski M., 2018: Innowacyjne rozwiązania dla Przemysłu 4.0, Automatyka Online, [electronic source] https://automatykaonline.pl/Artykuly/Przemysl-4.0/Innowacyjne-rozwiazania-dla-Przemyslu-4.02_9 [access: 22.12.2021].
- Blokdyk G., 2020: Data Transfer A Complete Guide, 5STARCOoks, Brendale, Australia.
- Bogacz R., Krupane B., 2021: Technologia GSM w metodach zdalnego odczytu liczników energii elektrycznej, PAR, [electronic source] <http://www.par.pl/Forum-mlodych/Kolo-Naukowe-Elektronikow-Praktykow/technologia-gsm-w-metodach-zdalnego-odczytu-licznikow-energii-elektrycznej> [access: 22.11.2021].
- Bolloju N., Khalifa M., Turban E., 2002: Integrating Knowledge Management into Enterprise Environments for the Next Generation Decision Support, Decision Support Systems 33, 163–176.
- Chaładyniak D., 2011: Wybrane technologie bezprzewodowej transmisji danych, Zeszyty Naukowe – Warszawska Wyższa Szkoła Informatyki 5(5), 87–101, [electronic source] http://zeszyty-naukowe.wysi.edu.pl/zeszyty/zeszyt5/Wybrane_Technologie_Bezprzewodowej_Transmisji_Danych.pdf [access: 08.02.2022].
- Cisco Systems, Cisco Secure Wireless Plant Solution, 2007: Wi-Fi-Based Sensor Networking for Industrial Environments, San Jose, CA, USA.
- Cupek R., 2021: Akwizycja danych w systemach przemysłowych, wnp.pl, [electronic source] <http://www.wnp.pl/artykuly/akwizycja-danych-w-systemach-przemyslowych,-46620000.html> [access: 24.11.2021].
- Ćwikła G., 2011: Automatyczna akwizycja danych z systemów produkcyjnych dla potrzeb systemów wspomagających zarządzanie przedsiębiorstwem, Wybrane Problemy Inżynierskie 2, 79–84.
- Ćwikła G., 2012: Elementy i systemy umożliwiające pozyskiwanie, analizę i prezentację danych produkcyjnych, Innowacje w Zarządzaniu i Inżynierii Produkcji, Oficyna Wydawnicza PTZP, Opole.
- Engineer Ambitiously, [electronic source] <https://digital.ni.com/public.nsf/allkb/5FFDF323C35C1B5386256F1C00622596> [access: 22.11.2021].
- Folga K., 2006: Bezprzewodowo w strukturze MESH, Computer World, [electronic source] https://www.computer-world.pl/news/317951_2/Bezprzewodowo.w.strukturze.MESH.html [access: 25.11.2021].
- Fraden J., 2010: Handbook of Modern Sensors Physics, Designs, and Applications, Springer, New York.
- Heimann B., Gerth W., Popp K., 2001: Mechatronics. Components, methods, examples, Wydawnictwo Naukowe PWN, Warszawa.
- Integral Solutions, [electronic source] <https://integralsolutions.pl/zarzadzanie-danymi> [access: 28.11.2021].

- Karbowniczek M., 2015: Czujniki indukcyjne i pojemnościowe w praktyce inżynierskiej, *Elektronika Praktyczna* 3, 133–135, [electronic source] <https://ep.com.pl/files/11031.pdf> [access: 20.12.2021].
- Kisielnicki J., 2006: Zarządzanie organizacją, Wyższa Szkoła Handlu i Prawa im. Łazarskiego, Warszawa.
- Kontratech, [electronic source] <https://kontratech.com/91-wylaczniki-krancowe> [access: 22.11.2021].
- Kruszyński Ł., 2015: Bezprzewodowa transmisja w przemysłowych systemach automatyki, *Automatyka B2B*, [electronic source] <https://automatykab2b.pl/technika/45442-bezprzewodowa-transmisja-w-przemyslowych-systemach-automatyki> [access: 12.02.2022].
- Kugelstadt T., Devlin-Allen K., 2014: For high-speed transmission, consider full-duplex RS-485, *Design World*, [electronic source] <https://www.designworldonline.com/high-speed-transmission-consider-full-duplex-rs-485/> [access: 25.11.2021].
- Laboratorium lokalnych i metropolitalnych sieci bezprzewodowych. Tryby pracy punktów dostępowych w sieciach standardu IEEE 802.11, Katedra Teleinformatyki, Politechnika Gdańska, [electronic source] <http://kti.eti.pg.gda.pl/ktilab/wifiap/files/Tryby.pdf> [access: 24.11.2021].
- Mamo F.T., Sikora A., Rathfelder Ch., 2017: Legacy to Industry 4.0: A Profibus Sniffer, *Journal of Physics Conference Series* 870(1), 012002, <https://doi.org/10.1088/1742-6596/870/1/012002>
- Mulaosmanovic A., 2015: Communication in industry by using the PROFINET protocol, *Military Technical Courier* 63(2), 146–160, <https://doi.org/10.5937/vojtehg63-6586>.
- Naskręt P., Bojanowski W., Pawlak K., 2005: Nowoczesne systemy transmisji danych w automatyce przemysłowej, VIII Konferencja Odlewnicza Technical 2005, 12–13 May, Nowa Sól, 81–90, [electronic source] http://www.technical.com.pl/files/exposition/Konferencje_VIII_Konferencja_Odlewnicza_Technical_geg7y.pdf [access: 16.12.2021].
- Pawar V.N., Sawant N.D., 2014: Wireless Transmission And Control, *Journal of science information* 4(2), 120–124, <https://doi.org/10.13140/RG.2.1.2378.8405>
- Pękala J., 2012: Koncepcja algorytmu sprawdzania kompletności danych w procesie ich wymiany między systemami informatycznymi przedsiębiorstw produkcyjnych, *Czasopismo Techniczne. Mechanika* 109, 8-M, 123–134.
- Piątek Z., 2021: Komunikacja bezprzewodowa w przemyśle, *Automatyka B2B*, [electronic source] <http://automatykab2b.pl/raporty/4536-komunikacja-bezprzewodowa-w-przemysle> [access: 24.11.2021].
- Raptis T.P., Passarella A., Conti M., 2019: Data Management in Industry 4.0: State of the Art and Open Challenges, *IEEE Access* 7, 97052–97093, <https://doi.org/10.1109/ACCESS.2019.2929296>
- Rudnicki M., 2014: Atmel umieścił na stronie nową wersję stosu Lightweight Mesh, *Elektronika B2B*, [electronic source] <https://elektronikab2b.pl/biznes/22214-atmel-umiescil-na-stronie-nowa-wersje-stosu-lightweight-mesh#.VvmpwOKLTdc> [access: 18.12.2021].
- Sade S., Husti I., Daróczy M., 2019: Industry 4.0 as a Key Enabler toward Successful Implementation of Total Quality Management Practices, *Periodica Polytechnica Social and Management Sciences* 27(2), 131–140, <https://doi.org/10.3311/PPso.12675>
- Sala D., 2007: Wspomaganie decyzji w procesach przygotowania produkcji z wykorzystaniem systemu ekspertowego, Wydział Zarządzania, Akademia Górniczo-Hutnicza im. Stanisława Staszica w Krakowie, Kraków [PhD thesis].
- Tomaszewski D., 2018: Standardy komunikacji bezprzewodowej dla urządzeń IoT, *Elektronika B2B*, [electronic source] <https://elektronikab2b.pl/technika/49873-standardy-komunikacji-bezprzewodowej-dla-urzedzen-iot> [access: 11.02.2022].
- TWT Automatyka, [electronic source] <https://twt.com.pl/pl/i/Czujniki-optyczne/3> [access: 21.12.2021].
- Tupa J., Steiner F., 2019: Industry 4.0 and business process management, *Tehnički Glasnik* 13(4), 349–355, <https://doi.org/10.31803/tg-20181008155243>
- Xu K., Li Y., Liu Ch., Liu X., Hao X., Gao J., Maropoulos P.G., 2020: Advanced Data Collection and Analysis in Data-Driven Manufacturing Process, *Chinese Journal of Mechanical Engineering* 33(1), 1–21, <https://doi.org/10.1186/s10033-020-00459-x>
- Yekini N.A., Adebarif F.A., Bello O., 2015: Data Communication & Networking, Hasfem Nigeria, Ogun State, Nigeria.